

# The *MagPi*

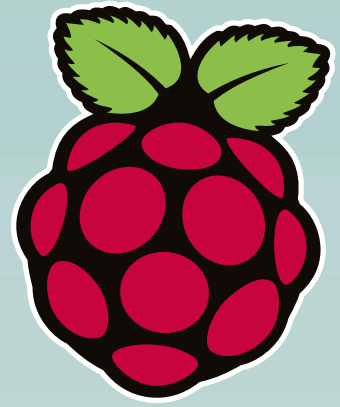

The official Raspberry Pi magazine

Issue 44 April 2016

[raspberrypi.org/magpi](http://raspberrypi.org/magpi)

## POWER UP YOUR LIFE WITH RASPBERRY PI

Five fun projects to help you improve & automate your world

### BUILD AN INFINITY MIRROR

Mike Cook concludes his cool two-parter

### RETRO VISION

Use an old TV with your new Pi Zero

### BLUETOOTH AUDIO GUIDE

Turn your Pi 3 into a music streamer

### WHAT IS PRESSURE?

Find out by doing some science with the Sense HAT

### Also inside:

- > NEW FEATURES COMING TO SONIC PI
- > MORE AMAZING COMMUNITY PROJECTS
- > TURN YOUR PI ZERO INTO A USB GADGET
- > OPEN GL: WHAT'S ALL THE FUSS ABOUT?

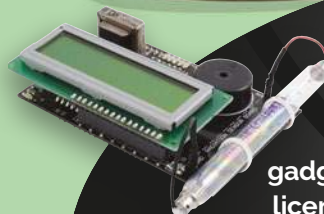

### 007 GADGETS

Pi-powered gadgets that are licensed to thrill

Issue 44 • Apr 2016 • £5.99



VNC SDK now available for

RASPBERRY PI!

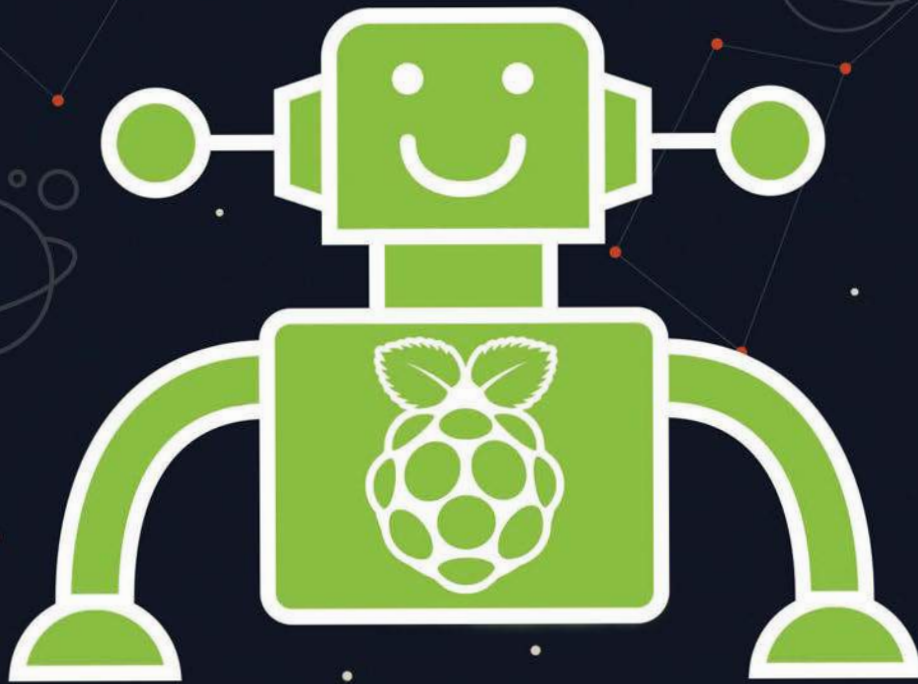

With VNC SDK you can connect VNC Viewers with VNC Servers easily over the Internet. Using VNC Cloud, no complicated network configuration at either end is required!

What will you create with VNC SDK?  
Check it out here: <https://developer.realvnc.com/>

REAL  
VNC

VNC DEVELOPER

Getting connected: [www.realvnc.com/products/vnc/raspberrypi/](http://www.realvnc.com/products/vnc/raspberrypi/)  
For more information contact [vncdeveloper@realvnc.com](mailto:vncdeveloper@realvnc.com)



# WELCOME TO THE OFFICIAL PI MAGAZINE!

**L**ife can be hectic, can't it? At times like this, it's the little things that suffer. You forget to record your favourite TV show, you miss the weather report, or – worst of all – you end up drinking cold coffee. As our features editor Rob Zwetsloot explains at the start of this month's cover feature, while technology has advanced to a point that we can navigate the globe with a tiny monolith stored in our pockets, there's still too much to do and too little time to do it. There's tons of great technology out there – all we've got to do is find new and interesting ways to make to work in our favour. The Raspberry Pi is the perfect example and we've put together five projects to demonstrate how you can use it to power up your life. You can get started today on page 20 – and, if you're inspired by our ideas, do let us know what little life hacks you have in mind using the Raspberry Pi.

For our other big feature this month, we've put together a top-secret dossier of James Bond-inspired hacks that Q himself would be proud of. Get started on page 66 and see what top-secret intel you can gather with these rather mischievous Raspberry Pi projects.

Enjoy the issue!

**Russell Barnes**  
Managing Editor



## THIS MONTH:

### 10 SONIC PI TAKES STRIDES

Find out what's new in the ultimate music coding application

### 20 POWER UP YOUR LIFE WITH PI

Use the Raspberry Pi to help with the little things in life

### 46 TURN YOUR LAPTOP INTO A PI

Follow our excellent USB Gadget guide presented in easy steps

### 66 JAMES BOND GADGETS UNCOVERED

Do try to bring them back in one piece, 007...

**FIND US ONLINE** [raspberrypi.org/magpi](http://raspberrypi.org/magpi)

**GET IN TOUCH** [magpi@raspberrypi.org](mailto:magpi@raspberrypi.org)

The **MagPi**



#### EDITORIAL

Managing Editor: **Russell Barnes**  
[russell@raspberrypi.org](mailto:russell@raspberrypi.org)  
Features Editor: **Rob Zwetsloot**  
Sub Editors: **Laura Clay, Phil King, Lorna Lynch**

#### DISTRIBUTION

**Seymour Distribution Ltd**  
2 East Poultry Ave  
London  
EC1A 9PT | +44 (0)207 429 4000

#### DESIGN

Critical Media: [criticalmedia.co.uk](http://criticalmedia.co.uk)  
Head of Design: **Dougal Matthews**  
Designers: **Lee Allen, Mike Kay**  
Cover photography: **Gareth Halfacree**

#### SUBSCRIPTIONS

Select Publisher Services Ltd  
PO Box 6337  
Bournemouth  
BH1 9EH | +44 (0)1202 586 848

#### PUBLISHING

For advertising & licensing:  
[russell@raspberrypi.org](mailto:russell@raspberrypi.org) +44 (0)7904 766523  
Publisher: **Liz Upton**  
CEO: **Eben Upton**

#### CONTRIBUTORS

**Sam Aaron, Wesley Archer, Mike Cook, Lucy Hattersley, Bernat Espigulé Pons, Brett Haines, Richard Hayler, Phil King, Matt Richardson, Ben Rogers, Richard Smedley & Francesco Vannini**



This magazine is printed on paper sourced from sustainable forests and the printer operates an environmental management system which has been assessed as conforming to ISO 14001.

The MagPi magazine is published by Raspberry Pi (Trading) Ltd., Mount Pleasant House, Cambridge, CB3 0RN. The publisher, editor and contributors accept no responsibility in respect of any omissions or errors relating to goods, products or services referred to or advertised in the magazine. Except where otherwise noted, content in this magazine is licensed under a Creative Commons Attribution-NonCommercial-ShareAlike 3.0 Unported (CC BY-NC-SA 3.0). ISSN: 2051-9982.



# Contents

Issue 44 April 2016

[raspberrypi.org/magpi](http://raspberrypi.org/magpi)

## TUTORIALS

- > **PI ZERO USB GADGET 46**  
Turn any computer into a Raspberry Pi!
- > **BLUETOOTH AUDIO WITH PI 3 50**  
Utilise the Pi 3's excellent Bluetooth functionality
- > **SONIC PI PT9: TRACKING BEATS 52**  
This month Sam Aaron explains Sonic Pi's tick system
- > **WHAT IS PRESSURE? 54**  
Learn science with the Sense HAT in part 2 of our series
- > **RCA OUTPUT FOR PI ZERO 56**  
ModMyPi.com shows us how to hook up to old TVs
- > **MIKE'S PI BAKERY 58**  
Join Mike for the second part of his Infinity Mirror project
- > **TIME-LAPSE WITH WOLFRAM 62**  
Experiment with the Pi camera and the Wolfram language

## COVER FEATURE

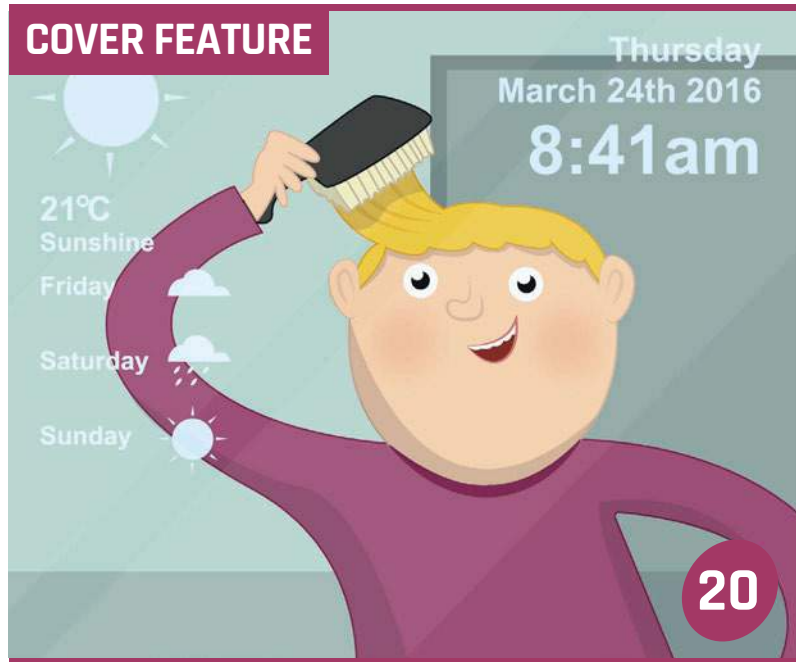

## POWER UP YOUR LIFE

Make your life that bit easier with the help of the Raspberry Pi

## IN THE NEWS

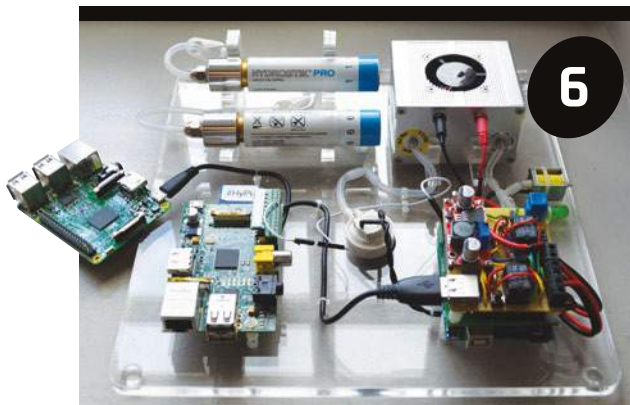

## THE PI 3 LAUNCH REPORT

See what happened at the launch of Raspberry Pi 3 last month in our event round-up

## OPEN GL 15



Find out what all the fuss is about in our look at what OpenGL support means for the Raspberry Pi 2 & 3

## CODE CLUBS

Learn how you could start a Code Club in your local area with a little help from The MagPi





**THE BIG FEATURE**

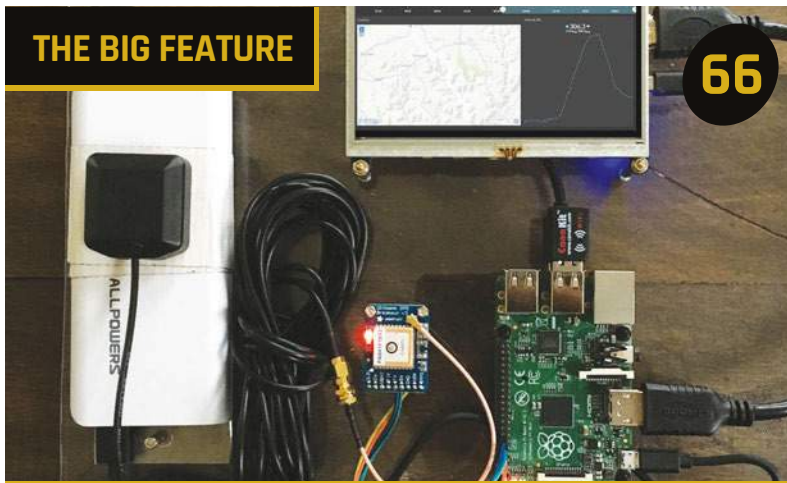

**66**

**JAMES BOND SPY PROJECTS**

Amazing Pi-powered gadgets with a licence to thrill. Oh, and James – do please try to return the equipment in one piece this time...

**3 Ucreate ASTRO PI KITS MUST BE WON!**



**95**

We've got three amazing U.Create Astro Pi kits to give away – jump across to our competition to find out more

**SUPER SONIC PI**



**10**

Sam Aaron talks us through the very latest version of Sonic Pi



**YOUR PROJECTS**



**36**

**GALAGA PI MINI ARCADE CABINET**

A flawlessly detailed recreation of the arcade classic

<p><b>SHEEP TAGGER</b> <b>38</b></p> <p>A useful RFID hack for farmers everywhere</p>	
<p><b>LICHEN BEACONS</b> <b>40</b></p> <p>An incredible digital sound art installation</p>	
<p><b>BURT BOT</b> <b>42</b></p> <p>Pi community blogger Average Man shows us his latest and greatest creation</p>	

**REGULARS**

- > NEWS **06**  
The biggest stories from the world of Raspberry Pi
- > TECHNICAL FAQ **74**  
If you've got a problem, we've got the answer
- > BOOK REVIEWS **82**  
The latest computer books you should be reading
- > THE FINAL WORLD **96**  
This month Matt Richardson celebrates a year in Pi

**COMMUNITY**

- > THIS MONTH IN PI **84**  
Discover what else has been happening this month
- > MIND THE SKILLS GAP **86**  
A report from the Manchester Digital Skills Festival
- > EVENTS **88**  
Find a community gathering near you and get involved!
- > LETTERS **92**  
What do you think about stuff? We want to know...

**REVIEWS**

- > PIMORONI P8266 IOT **76**
- > CHROMIUM RPI 0.4.1 **78**
- > RASPBERRY PI ZERO KIT **80**
- > RASPBERRY SQUID **81**

# RASPBERRY PI 3 LAUNCH REPORT

The latest Raspberry Pi went on sale last month, with launch events in London to celebrate both the Pi 3 and the Pi's fourth birthday

**T**he morning of Monday 29 February saw a brisk yet very bright dawn on London's South Bank, with the low winter sun creating sharp shadows across the city. We were looking at it from high above in the Shard at about 8am, an hour after the Raspberry Pi 3 had been announced, and preparing for a live stream from element14 to celebrate the fourth birthday of the Raspberry Pi and to talk about the Raspberry Pi 3.

**Below** Projects and Pi hacks were everywhere at the events to show off the strength of the community

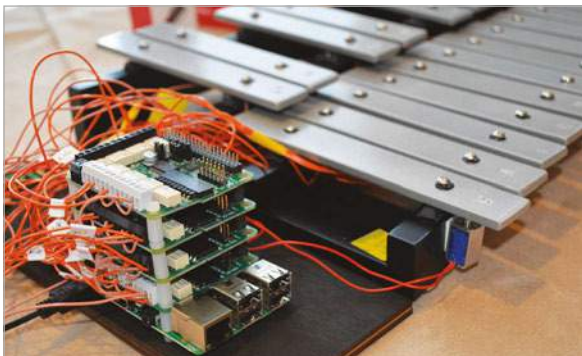

"Four years old, eight million units in the wild - we thought it would be fun to do something to celebrate," Eben Upton, CEO of Raspberry Pi Trading and co-creator of the original Raspberry Pi, explained during his talk at the launch conference. "So we've got a new product: Raspberry Pi 3."

The 8 million number for Pis sold is also an important new milestone - this makes the Raspberry Pi the best selling British computer ever, finally beating the Amstrad PCW. Later on in the day, Eben would disclose that the next milestone goal was 12 million, a number that would make the Pi the third bestselling computer of all time, only behind Macs and PCs.

Revealing the Raspberry Pi 3 properly to the world, Eben got to detail all the changes and updates made to the Pi 3 that mattered: 802.11n wireless LAN; Bluetooth Classic and Low Energy; a much

faster 64-bit processor that, even when running 32-bit code, is much better than the previous model; and a slightly upgraded VideoCore IV chip. You can read all about the full range of new features in detail in issue 43 of *The MagPi*, including our own benchmarks.

Another surprise was waiting, though, as Eben revealed the Compute Module 3; this is an upgrade to the original Compute Module used in projects prototyped on the Pi, this time with the BCM2837 chip now seen in the Pi 3.

"There are two missing-in-action products in our roadmap," Eben explained when asked about the naming. "The Compute Module 2 and the Raspberry Pi 2 Model A. What happened to those products is that the Raspberry Pi 3 came in nice and quickly and kind of closed the window for them. We were selling so many 2Bs that all our chips were getting pulled into 2B; by the time we

## PROJECT SHOWCASE

Some of the great projects showing off what the Pi 3 can do...

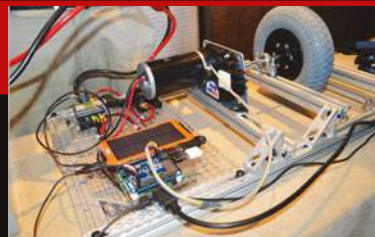

### Windows 10 IoT wheel

Using Pi 3 and Windows 10, the motor attached to the wheel can be controlled. It also gives a feedback loop, so you know how it's performing.



### Minecraft speed demo

A simple demo that showed off the speed of the Pi 3 versus the Pi 2, having each Pi calculate pi within *Minecraft*.





Eben Upton, CEO of Raspberry Pi Trading and co-creator of the original Raspberry Pi, was there to kick off the conference

had enough pipeline to build those other products, we were only two to three months away from the [Pi] 3 launch. We expect the 3 to be around for a little longer than 2 was, so we're expecting that there should be a 3A."

A similar conference was held at the RC Components launch

will give kids the confidence to make a start in computing. He explained that the family computer is a part of the family infrastructure: you can't mess around with it. He extended his analogy to the family car – something you could feasibly take apart and put together again, but

“ We expect Pi 3 to be around for a little longer than 2 was ”

event later that morning at the Globe. Eben gave a more personal presentation about the Raspberry Pi: "I owe everything I have in my life to the hardware I had as a kid. I hope there are kids who will look back on the Raspberry Pi, and particularly the Raspberry Pi 3, with the same sort of affection."

Eben hoped that the Raspberry Pi as a secondary 'breakable' computer

are very likely to do incorrectly. A broken car, and a broken computer, severely inconveniences a family.

On display at both locations was an excellent selection of projects from a diverse range of people that celebrate the use of the Raspberry Pi, from 360-degree camera hats and motors with feedback loops, to student robots and theme park dinosaur attractions. The

## ANDROID PI

### We followed up with Eben about his thoughts on Android on Raspberry Pi

During the event, a question arose about whether Android might be supported on the Pi 3. A short answer of yes was followed up by a more thorough explanation.

"[This is thanks to] all of the things that have changed over the past six months," Eben explained. "We now have an open graphics driver stack which we're currently shipping as a public beta, and there's been a lot of work done by the community to port both Android and Chrome OS to run on top of that integration – [it's] kind of an exciting thing."

Android has been tried before on the Raspberry Pi, but the results were never very promising until the recent driver stack beta.

"I think Android would run pretty well, though I think there's still a bit of work to do on driver performance and stability," Eben elaborated. "Obvious use case is to run apps from the Android store. Would certainly be nice to see that."



Pi community is large and still expanding with every new release – day one stock of the Raspberry Pi 3 sold out in a lot of places – and the Pi 3 looks like it will not only help that community to grow but also further the educational mission of the Raspberry Pi Foundation.



### Blackgang Chine dinosaurs

A scale model of a T Rex attraction from the Blackgang Chine theme park, shown off by its creator Lucy Rogers.

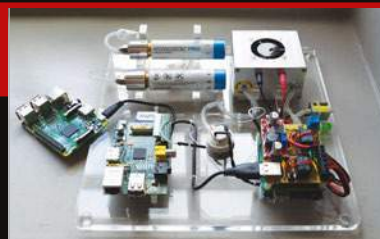

### Hydrogen-powered Pi

The HyPi uses hydrogen fuel cells to power the Raspberry Pi. An incredibly clean way to run our favourite computer!



### pi-top

With a new prototype board and Raspberry Pi that you can easily slot in, the pi-top range is going to get a serious power boost very soon.





The lobby was occupied by everyone's favourite cardboard spaceman, Tim Peake



The marketplace was packed with retailers, all selling amazing Pi merchandise and components

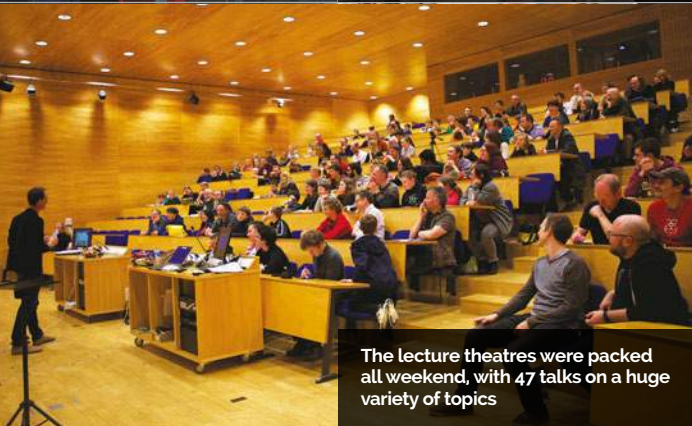

The lecture theatres were packed all weekend, with 47 talks on a huge variety of topics



People of all ages came to see what they could do with a Raspberry Pi; some even went home with kits to get started

# THE BIG BIRTHDAY BASH

It's been four years since the Raspberry Pi was released, and everyone celebrated in style

**D**uring the launch of the Raspberry Pi 3, one of the sentiments that Eben Upton, co-creator of the Pi and CEO of Raspberry Pi Trading, mentioned a few times was that having a birthday on 29 February makes it harder to celebrate the true birthday of the Pi. As we're now in another leap year, it's time to make it a big celebration.

crowded around amazing demos that showed off the true power of the Raspberry Pi: to open up computing to everyone, no matter their age or background.

### Party all day long

As well as the daytime convention party, there was the evening party on Saturday which reportedly required 110 pizzas (we were too

“ An incredible weekend filled with happy, amazing people ”

Held on the weekend of 5-6 March in the Raspberry Pi's home town of Cambridge, the event saw 1,500 people turn up to pack the Cambridge Computer Lab and show off their love for a very small and very cheap computer. It was an incredible sight as people piled into talks and

busy eating them to count) and included the most raspberry-flavoured delights you're likely to see for the rest of the year.

It was an incredible weekend filled with happy and amazing people that really brought the community together. Same time next year, then?





# Jumpstart Raspberry Pi Projects with *Cayenne*

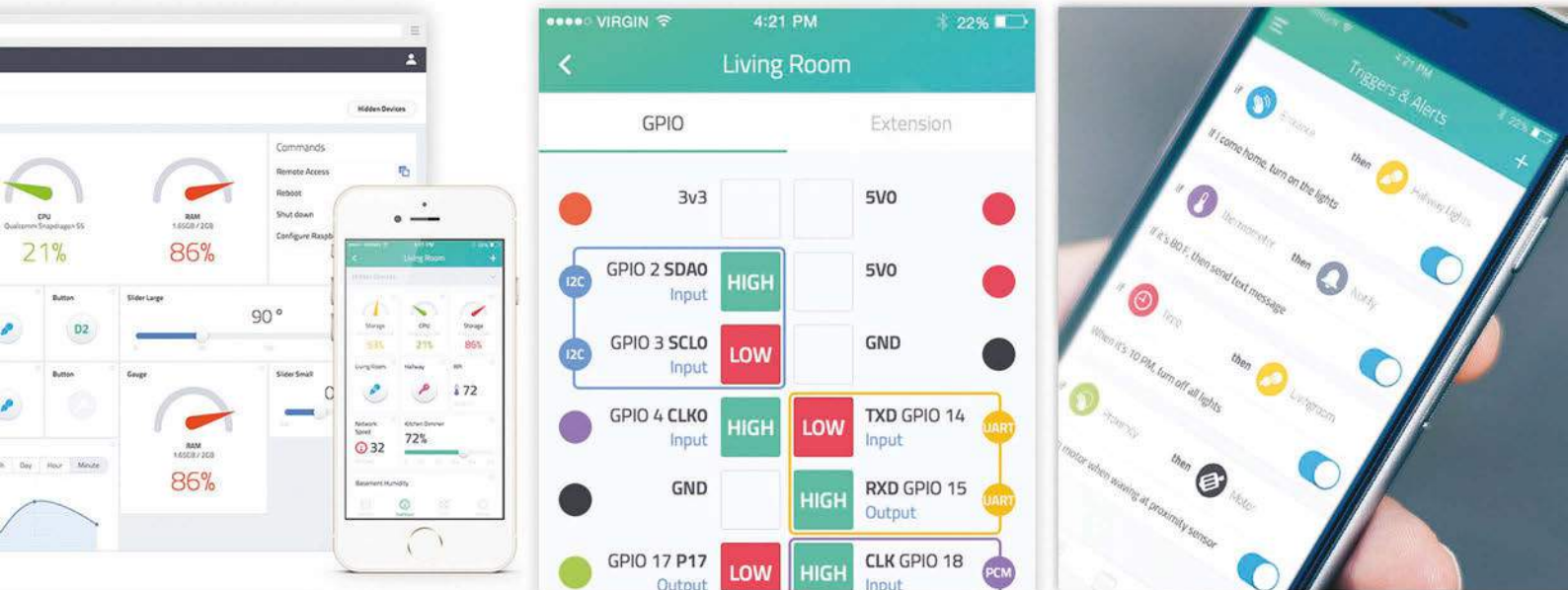

The first **drag-and-drop project builder** developed for makers to quickly design and prototype amazing Raspberry Pi IoT projects

- ✔ Customizable online dashboard with drag-and-drop widgets
- ✔ Remotely control sensors, motors, actuators, GPIO boards, and more
- ✔ Create triggers and threshold alerts for devices, events, and actions
- ✔ Schedule one-time or multi-device events for easy automation
- ✔ Start your projects directly from the mobile app



Get *Cayenne* for FREE and start building today!  
[cayenne-mydevices.com/magpi](https://cayenne-mydevices.com/magpi)





# SUPER SONIC PI

The latest version of Sonic Pi features many improvements, with some even more exciting additions in the pipeline. We chat to its creator, Dr Sam Aaron...

**M**usical programming environment Sonic Pi ([sonic-pi.net](http://sonic-pi.net)) is getting a raft of new features for version 2.10, due out in the next few weeks. New synths include three chiptune sounds based on the classic NES games console. There are four more FX to play with: the human speech-like ‘vowel’, ‘whammy’ and ‘octaver’ transposition effects, and ‘mono’ to merge stereo sample channels. There’s also support for working with large directories of

samples via a powerful new filter system. Other additions include ‘doubles’ and ‘halves’ to generate ring values, and an ‘on’ command to run a block of code if a condition is met. See [magpi.cc/21D4x8o](http://magpi.cc/21D4x8o) for the full list of changes.

As its creator Dr Sam Aaron tells us, it’s all part of the ongoing process to keep improving Sonic Pi, to make it more flexible for live-coding music performances, and also simpler to work with in the classroom. “One of the fundamental aspects of Sonic Pi, which people really haven’t figured out yet, is that it has incredible depth as a result of a lot of deep thought. For example, the randomisation being massively deterministic.” One new randomisation function in v2.10 is the ‘pick’ command, which is similar to ‘shuffle’ but with the potential for duplicates. “When people start using randomisation as a reliable reproducible building block for their compositions, then these kind of functions become very important.”

## Tuning it up

The new `set_cent_tuning` command should also come in handy for tuning Sonic Pi to use alongside other musical instruments. “I did a gig before Christmas with a concert pianist

and he said ‘Sam, can you tune Sonic Pi up?’ and I could, but it was a bit of a fuff so I built this thing to make it easier.” Sam has also live-coded with bands and guitarists, and views Sonic Pi as “a musical instrument which happens to be very easy to code with.” He also thinks it’s important that Sonic Pi is seen as more than a coding tool, even for its educational purpose: “People say ‘I want to study this because I’ve seen people do amazing things with it’.”

Many new features arise from Sam observing what children try out in Sonic Pi during school workshops. Another source of ideas is his own rehearsals for live-coding gigs. “I practise with the system two hours a day, most days. During a practice session, I will keep a diary of thoughts... things about ‘why isn’t this so simple?’, ‘this should be possible’... I use that list for driving feature developments.”

Developing Sonic Pi at the University of Cambridge’s Computer Laboratory, Sam says the work is split into three main categories. As well as software development, he uses it as a live performance instrument, and goes into schools and universities to do workshops. “All of those things, I try to do with the Raspberry Pi if possible.”

## UPDATING SONIC PI



Sonic Pi comes pre-installed with Raspbian, but can be downloaded manually from [sonic-pi.net](http://sonic-pi.net). To check which version you’re using, click the Preferences button in Sonic Pi, then the Updates tab. To update Sonic Pi from the terminal, type: `sudo apt-get update && sudo apt-get install sonic-pi`. If you want to install the latest pre-release dev version from source, visit the GitHub page: [magpi.cc/1UG7PYL](http://magpi.cc/1UG7PYL).



## SONIC PI BOOK

While Sonic Pi has a built-in Help section, you can learn even more tricks and techniques from our Essentials book, written by Sam Aaron himself. By reading the tutorials, you'll be able to code up some phat bass, sparkling synth leads, and start practising for your first live-coding gig. The book is available in print and digital formats, including a downloadable PDF: [magpi.cc/sonic-pi-book](http://magpi.cc/sonic-pi-book).



While Sonic Pi is also available for Windows and Mac OS X – with over 200,000 downloads – it comes pre-installed on the Pi's Raspbian OS, and the project is funded by the Raspberry Pi Foundation. Back in late 2012, a few months after the Pi's launch, Sam was asked to come up with a way of engaging schoolchildren with creative coding. Sonic Pi was originally conceived as a "guerrilla project" with a short three-month development period in which to "design a fully built system, collaborate with a teacher [Carrie-Anne Philbin], design a scheme of work, deliver it in lessons, and evaluate it!"

## Education and the future

Since then, Sonic Pi has developed into a sophisticated educational tool – for both computing and music curricula. It's based on Ruby, which Sam regards as an ideal language for educational purposes, particularly for bridging the gap between block- and text-based coding. Sonic Pi is designed to be easily accessible for everyone, including those with no musical background. Nor do users require a deep understanding of the language to start using it: "If you only need to do musically simple things, then the code is very, very simple."

Sam is also very interested in 'liveness': the ability to change things on the fly while running

code, as introduced in Sonic Pi v2.0. "It leads to a deeper engagement, a faster iteration of experimentation, play, and risk-taking. And then, when you start doing an endeavour in front of an audience, it fundamentally changes how you perceive programming."

As for the future of Sonic Pi, the next major addition revolves around input/output, with support for MIDI, DMX, and the Pi's GPIO pins; this could be used to sync a light show with the music, for instance. Sam is already working on this, using Erlang to relay messages with reliability and low latency, although it's likely to take many months to perfect.

Most exciting is the prospect of sharing messages with other computers running Sonic Pi for jamming sessions, with the potential to create Sonic Pi 'orchestras' in schools. "I could also send those messages to a web server and have it forward them on to other people around the world, at which point I have distributed jamming. Or for streaming, where I could actually perform to other people... all they need is a version of Sonic Pi." The ultimate aim is to enable children to screencast their performances with great ease and very low bandwidth requirements, with the potential for others to listen in via 'radio stations' within Sonic Pi.



## SONIC PI IN SPACE!

If you're very quick, you may still have the chance to send your Sonic Pi composition into space, to be enjoyed by Tim Peake aboard the ISS. The closing date for competition entries is 31 March. See [magpi.cc/1UGa7qs](http://magpi.cc/1UGa7qs) for more details.

## LIVE PERFORMANCE



Sam does regular live-coding performances using Sonic Pi at venues all over the world – including nightclubs, arts festivals, and tech conferences – and has recently been invited to perform at Moogfest 2016: "Sonic Pi on the Raspberry Pi is now being seen by the music industry as a serious musical tool." He also does a regular Thursday night live stream: [livecoding.tv/samaaron](http://livecoding.tv/samaaron). When performing, he uses a Raspberry Pi with an IQaudIO Pi-DAC sound card, plus a big screen to show how he's live coding to alter the music. His main tip for novice live coders is to learn to touch type, have lots of patience, and keep practising regularly.



# CREATIVE TECHNOLOGISTS EXHIBITION

Join nine talented young people on 23 April at Raspberry Pi Towers to see how they've merged technology and art for their end-of-year exhibition

## WIN TICKETS TO THE EXHIBITION



While the event is free, available spaces are in short supply. Since we're big shots in the world of Raspberry Pi, however, we've managed to secure three sets of two tickets. Want to take a friend or relative to see how art meets tech? Email us at [competition@raspberrypi.org](mailto:competition@raspberrypi.org) with your details, using 'New Works Exhibition' as the subject.

**T**he Raspberry Pi Creative Technologists programme is open to artistic individuals aged 17-21, with the aim to help guide those selected to use technology to make their ideas and projects a reality. The 2016 cohort have spent the last year being mentored by the Raspberry Pi Foundation and various industry partners, attending field trips and getting the support they need to move their own projects forward.

The Creative Technologists' experience culminates with an end-of-year exhibition in which each Creative Technologist shows off their innovative project that combines technology with art and other creative pursuits. The New Works Exhibition is taking place on 23 April and will showcase their accomplishments and demonstrate how diverse technology can be

when it comes to being creative, no matter the form.

We're certainly looking forward to what they have in store. The 2016 cohort comes from all areas of the arts and technology spectrum, with specialisations including music, animation, programming, engineering, and writing – there's even a magician.

This exhibition will comprise an exclusive opening night, with an open-access exhibition the following day. If you're interested in a free ticket to the 2016 Creative Technologists' New Works Exhibition at Raspberry Pi's shiny new HQ in the heart of Cambridge, you can learn more about it at [rpct.io](http://rpct.io) and apply for your free ticket via [magpi.cc/rpct2016](http://magpi.cc/rpct2016). We've also secured some tickets to give away – see the boxout on this page for details.



# STRATO

## Pi @ work

### ✓ Power supply

9-28Vdc power supply, with surge and reverse polarity protection

### ✓ Real time clock

real time clock with on-board lithium back-up battery

### ✓ Serial ports

standard RS-232 and RS-485 interfaces to the Raspberry Pi serial line, with opto-isolator and electrostatic discharge protection

### ✓ Buzzer

on-board buzzer, connected to an I/O pin of the Raspberry Pi board for acoustic feedback

### ✓ UPS version with hardware watchdog

integrated uninterruptible power supply, external lead-acid 12V battery required



### ✓ Strato Pi Server

pre-assembled and tested Raspberry Pi 2 Model B with Strato Pi board (base or UPS version) in a standard 4 modules DIN rail case

Save 10% on our online store

discount code: MAGPI10



# RASPBERRY PI 3 OVERHEATING NOT A PROBLEM

**Eben Upton** says you won't experience high temperatures in normal use

**Below** The new Raspberry Pi 3's CPU is much faster, but can get quite hot under a heavy workload

**S**hortly after the Raspberry Pi 3 was released, some concerns were raised over the temperature of the BCM2837 chip that powers the new Pi. A very small number of users had found the temperature of their CPU reaching up to 100 degrees. Aware of the issue, the Raspberry Pi hardware team investigated the claims.

"In everyday use I would say 'never'," Eben Upton told ZDNet ([magpi.cc/1TJfNRp](http://magpi.cc/1TJfNRp)) in response to a question about how often boards would reach temperatures where users need to throttle their speed. The culprit seemed to be unnaturally high load as the result of benchmarking the Raspberry Pi 3, something the vast majority of people won't be doing.

We spoke to James Adams, director of hardware at Raspberry

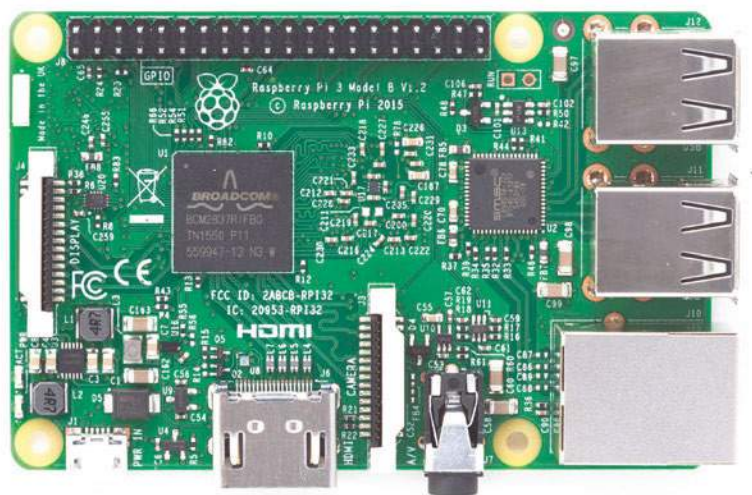

Pi, for more information: "We knew the Pi 3 was going to be able to generate significantly more heat under heavy load, but that's just physics and the price you pay for more performance... We have of course been testing the Pi 3's heat output under various loads and our

conclusions were that it was still OK without a heatsink: in the majority of normal use cases we don't see it hitting the temperature limit."

He tells us that tests have shown the Raspberry Pi 3 sitting at about 20 degrees above ambient/room temperature while idling on the desktop environment, which is completely normal for any piece of hardware.

"Extended loads of any type won't damage the Pi, as the BCM2837 and components will operate fine at higher temperature indefinitely," James assures us. "Heavy CPU and/or GPU load will increase the temperature, but the Pi will throttle itself to keep the die temperature at 85°C or lower."

Regardless, a new firmware revision has been pushed to improve this throttling behaviour of the CPU.

## JUST IN CASE...

As Eben says, it will likely never happen unless you decide to put some serious load on the CPU. However, if that's what you plan to do, then it might be worth being prepared for high temperatures. We asked James what people could do about it:

"Adding a small heatsink will allow the Pi to dissipate heat faster and therefore be less prone to throttling in heavy use cases."

A few places sell heatsinks for the Raspberry Pi already – ModMyPi has a set ([magpi.cc/1XqTJJo](http://magpi.cc/1XqTJJo)), but your usual supplier of Pi goods will likely stock them as well.



The BCM2837 starts to throttle itself once it starts hitting particularly high temperatures



# OPENGL DRIVER IN RASPBIBIAN

Pi 3 may be the next leap in hardware, but the OpenGL driver is the next leap in software for the Raspberry Pi

## OPENGL FACTSHEET

**Name:**  
Open Graphics Library (OpenGL)

**Description:**  
API for 2D and 3D vector graphics

**Function:**  
Allows for GPU hardware acceleration

**First released:**  
January 1992

**Compatible Raspberry Pis:**  
Raspberry Pi 2 and Pi 3

**I**t's been a long time coming, but finally the Raspberry Pi is getting close to having a complete, open-source OpenGL driver stack. What this means is that developers will have access to hardware acceleration from the GPU. This is a huge step for the software on the Pi; in essence, it will let software on Raspbian have access to more power, especially graphically intense applications like video games.

While it may have been four years since the release of the Raspberry Pi until its inclusion, this particular driver beta is the result of two years of work by Eric Anholt. Eric is an open-source developer at Broadcom who has done a lot of work on open-source graphics for Intel on MESA. He began working on it shortly after joining Broadcom.

"The 3D side of things has been delightful," Eric tells us. "I had some sample triangle-drawing code for the GPU that [VideoCore engineer] Scott Mansell had reverse-engineered; if you don't know, getting from 'doesn't draw anything' to 'draws a single



Some games work on OpenGL, like *Borderlands 2*, enabling their release on multiple platforms and not just Windows

triangle' is about half of the work of building a full OpenGL driver. Between that, the excellent documentation, and a software simulator to use for testing and debugging, I was able to produce a driver that was drawing triangles within a week of starting at Broadcom."

## More to do

Currently, the beta is in 'good shape' and most of the work now involves getting displays working and everything merged into the kernel. For a stable release, Eric tells us there are "more than

a few months, less than a few years" of work left.

"I keep writing patches continually and merging code to the upstream repositories, and it'll be trickling out as releases happen," he reveals. The drivers are already being used to port Chromium OS to the Pi, and Android will hopefully follow soon. Users are also excited about the possibilities, so this could well result in a wave of better and new software for Raspbian and the Raspberry Pi. If you want to contribute, Eric would love to work with you. Find out how here: [magpi.cc/1TFBU1q](http://magpi.cc/1TFBU1q)



## GAME DEVELOPMENT

One of the interesting things about the OpenGL driver is that it also allows for better video game support. If you've been keeping an eye on the Raspberry Pi blog, you'll know that a selection of games were recently released by YoYo Games for the Pi ([magpi.cc/1Xnk7Uz](http://magpi.cc/1Xnk7Uz)). This is the same studio behind GameMaker: Studio, a game development suite. During a chat with Mike Dailly from YoYo games, he mentioned that the OpenGL release made a port of the full Studio software to Raspberry Pi one step closer. Maybe one day you could be developing games professionally on the Raspberry Pi.

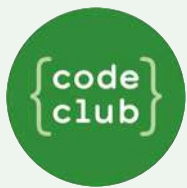

# START A CODE CLUB IN YOUR AREA

Are you a teacher or after-school club organiser interested in setting up a Code Club in your area? Here's how simple it is to get started...

**I**t's easier than you think to run a Code Club yourself: you don't need existing coding skills, just a can-do attitude to get stuck in, learning alongside your students for an hour a week!

If you haven't yet heard about Code Club, it's a UK-based not-for-profit organisation offering free learning materials and support for teachers, volunteers, and parents running after-school coding clubs for children aged 9-11.

Code Club's specially designed projects offer structured and fun content for the clubs. The projects are step-by-step guides

for children to follow to create animations, games, websites, and much more. Children build up their programming skills as they move through the projects. There are also challenges to provide opportunities to apply what they've learnt.

Caroline Harding, a Year 4 teacher who helps to run a Code Club at her school in Croydon, told us about the benefits the club has brought the children. "Making Code Club available to the children in our school has helped tremendously with their confidence and engagement in coding and computing in general,"

she explains. "It taps into their problem-solving skills and enables them to develop their critical thinking skills.

"Programming and coding is an area of the curriculum that many staff can find intimidating. Knowing that the children have some experience of the program can help ease some anxieties and enables that 'have a go' attitude!"

By starting a club at your school, you'll be joining a huge community of teachers who do the same thing – around 50% of Code Clubs are run by teachers.

If you're considering getting a Code Club started, we've come up with a few tips to help you.

## Register your club online

To access Code Club's project materials, you will need to register online. You can sign up as a Code Club Host at [codeclub.org.uk/start-a-club](http://codeclub.org.uk/start-a-club), making sure to use your school email address so we can validate you as a teacher.

Once you've entered your details, you will be able to select the option to run the club yourself. Your club will then be automatically activated and you'll have immediate access to all Code Club's online resources.

Code Club has projects in three different coding languages: Scratch, HTML/CSS, and Python. Beginning

Below Code Club allows children to experiment and invent, using different languages to create their own games, animations, and websites







Left There is no cost involved in starting a Code Club. It's free for schools, and the kids who attend

with Scratch is recommended, as this visual block-based language provides a great introduction to key programming concepts. If your pupils are already experienced with Scratch, though, you may wish to get started with HTML/CSS or Python. There are twelve Code Club projects in each language, to keep your club occupied for a full term.

### Your first Code Club

It's worth preparing for your first Code Club session by working through the project in advance, so that you are aware of all the instructions and the places where pupils could possibly get stuck.

Code Club it offers children and teachers the opportunity to get creative with coding. It's a chance to experiment and invent, helping children to learn an important skill for their future, while engaging with technology and creating things that they can get excited about.

The model can be adapted to suit different venues and educational needs. Most clubs run through one coding project per week, but some children like to spend longer perfecting their designs. Some clubs have pairs of students sharing computers, and many also like to experiment with physical computing. You can customise your club to suit you and the children.

### Code Club in practice

There are thousands of teachers running their own Code Clubs across the country, and around the world. We spoke to Matthew Cave, assistant headteacher at West Town Lane Academy in Bristol, about his club. Beginning with Year 5 and 6 students, Matthew and his team introduced Code Club's Scratch projects for all Key Stage 2 children. Now, they have a whole-school approach, with Scratch Jr introduced for Key Stage 1, and they have invested in new technology including Lego WeDo and My Romo. "We've been running our Code Club for over a year now, with 40 children attending. The club is in high demand," says Matthew.

Code Club's fun approach has provided other benefits: "It's amazing to see the sense of achievement the children get when they finish their projects. We can really see them starting to persevere with the tasks in Code Club, using analytical thinking to troubleshoot."

What advice does Matthew have for teachers who are thinking of starting a club? "It's dead easy, so take the plunge! The children will run with it, so don't worry about not being an expert."

Learn more about Code Club via [codeclub.org.uk](http://codeclub.org.uk).

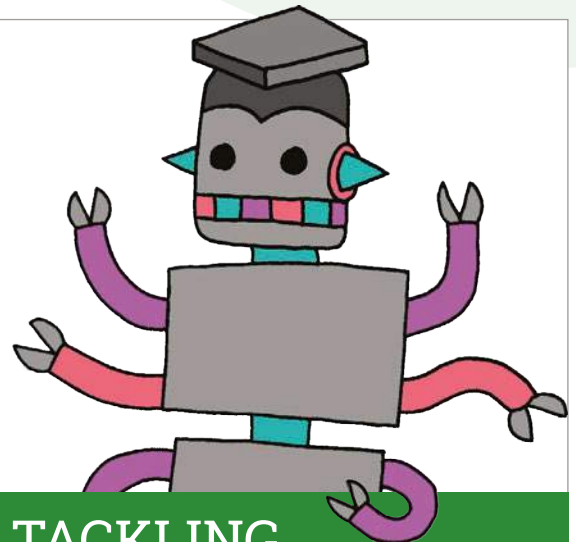

## TACKLING THE COMPUTING CURRICULUM

For teachers, running an after-school Code Club can help build confidence in teaching the computing curriculum and in integrating computer science into everyday lessons.

If you or someone you know are keen to get some additional, more formal training, you may be interested in Code Club's Teacher Training courses. There are three modules on offer, focusing on 'Computational Thinking', 'Programming & Networks', and 'The Internet'.

Many of the sessions are now free for teachers, so if you are interested, you can make an enquiry with the Code Club team by emailing [hello@codeclubpro.org](mailto:hello@codeclubpro.org).

# CEEDuniverse

LEARN  
PLAY  
CREATE

Discover a world of science fiction grounded in computing reality with pi-top's flagship learning software!

Learn to code, make circuits and create hardware with your friends using **CEEDuniverse** a massive multiplayer online game. Perfect for added engagement to STEAM classes and home learning! **CEEDuniverse** comes free with all pi-top devices.

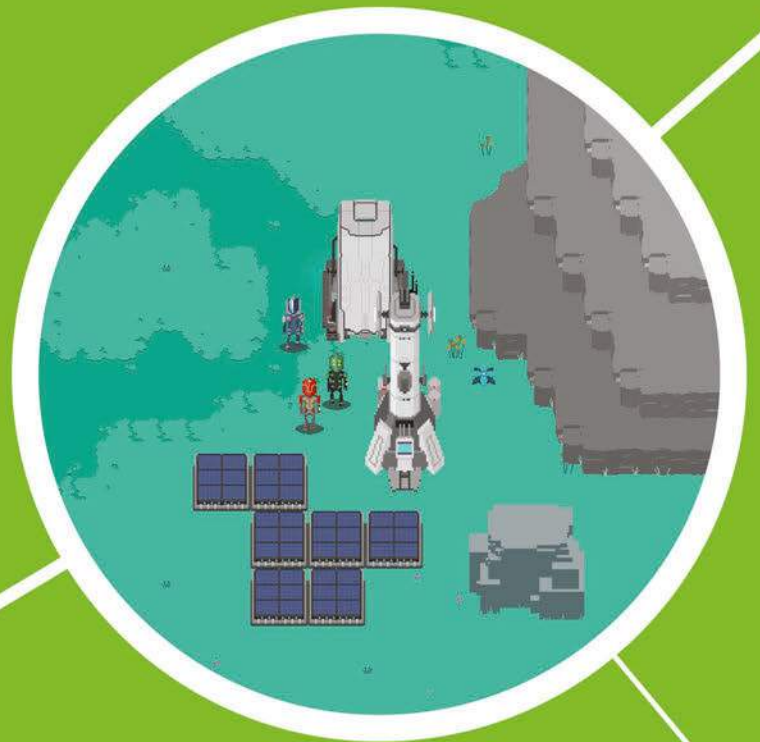

Build an outpost with your friends!



Uncover hidden secrets and learn to code!



Learn to build circuits in game!



What will you do in **CEEDuniverse**?

[WWW.PI-TOP.COM](http://WWW.PI-TOP.COM)



# pi-top

AVAILABLE AT [WWW.PI-TOP.COM](http://WWW.PI-TOP.COM)

WORLDWIDE SHIPPING  
Colours in Green or Grey

World's First Raspberry Pi laptop.

12Hr Battery Life  
13.3" HD Screen

Accessible Modular Components  
& RPi

Compatible with all models of  
Raspberry Pi

**\$299** excluding VAT

MagPi Review



# pi-topCEED

pi-topCEED is the easiest way to  
use your Raspberry Pi!

13.3" HD Screen

Front facing access to the  
Raspberry Pi and components

Compatible with all models of  
Raspberry Pi

**\$99** excluding VAT



"I'd love to see a pi-topCEED  
in every classroom."

— Eben Upton, Founder & CEO of RPi

# POWER UP YOUR LIFE WITH RASPBERRY PI

Make your life that little bit easier, thanks to the Raspberry Pi

**L**ife in 2016 is hectic. While technological advancements have made certain aspects of life easier than they've ever been (thank you, series link button and Google Maps), we've all still got so much to do and only so much time to do it in.

Life doesn't have to be that way, though, especially with the amount of technology that you're probably not utilising. We can't add hours to the day, but we can definitely try to use them better.

We've thought up five ways you can hack your life with a Raspberry Pi to make it just a little bit easier. With a minimal amount of work now, you can free up precious time in your schedule and reduce the stress in your life.

## WAKE UP

Start your day right with your morning brew. Whether that's tea or coffee, you want to make sure you get the very best cup you can. Here's how to make a better cuppa

PG 22

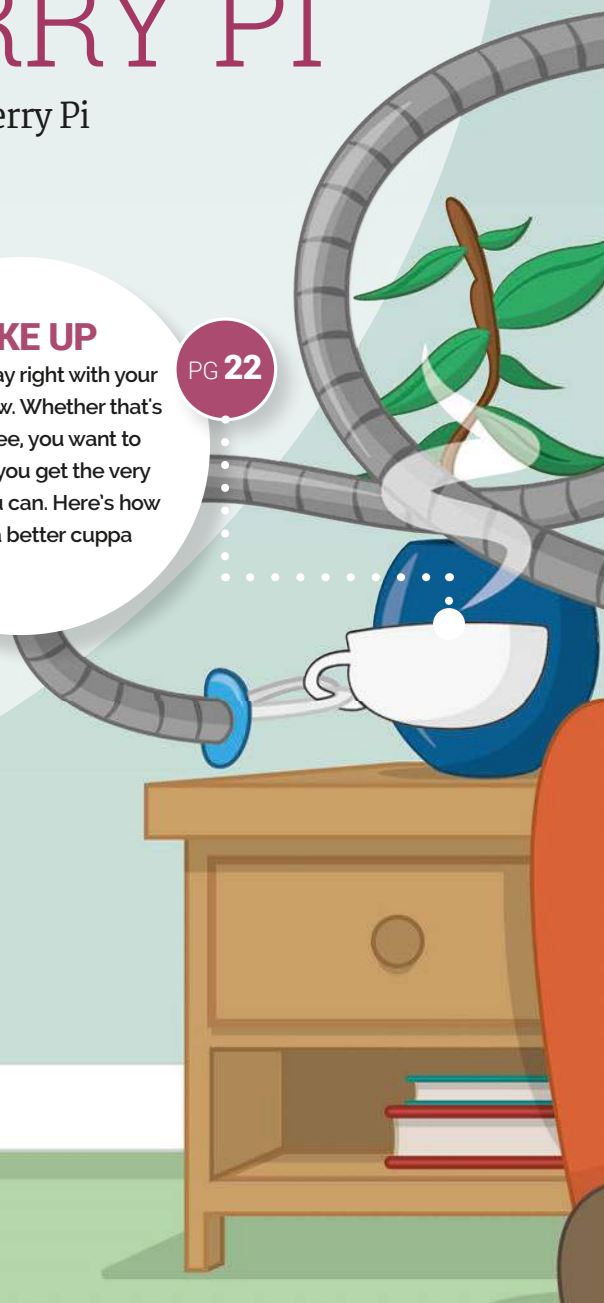



### EVENING

Once you get back home, you can relax for the rest of the day. Fire up your supercharged media centre and lose yourself in your favourite movie or TV show, with the least amount of hassle

PG 32

### LUNCHTIME

Having a bit of lunch at work and want to check everything is OK at home? Is the baby asleep? Has anyone stolen your amazing magic mirror? Log into your teddy cam in a browser to find out

PG 28

### AFTERNOON

If you realise you'll be working a bit late and nobody's around to feed the hamster, not to worry. With the hamster feeder, you can tweet out a hashtag and your little pet gets a treat

PG 30

### GETTING READY TO GO

You should listen to your mum and always have a look in the mirror before you leave the house. With this magic mirror, you can check your hair, the weather, and the news

PG 24

# KETTLE TEMPERATURE ALARM

Start your day right with the perfect cup of tea or coffee. How? It's all about the temperature. Here's how to take control of your kettle...

## You'll Need

- > Pi and Raspbian Jessie  
[magpi.cc/1U7aNqf](http://magpi.cc/1U7aNqf)
- > Display-o-tron 3000  
[magpi.cc/1T4p0CQ](http://magpi.cc/1T4p0CQ)
- > High-temperature, waterproof temperature sensor  
[magpi.cc/1T4p4CS](http://magpi.cc/1T4p4CS)
- > Buzzer
- > Breadboard and wires

**S**ome of you may be wondering what we mean by 'perfect temperature' for a cuppa; did you know that most black teas (the type of tea, that is, not whether or not it has milk) brew best at 95°C? This includes black teas such as PG Tips, Tetley, Yorkshire, and even chai tea, while other teas (green, white) brew better at different temperatures. Ground coffee requires about 80–85 degrees to brew properly. Seriously.

### >STEP-01 Wire up the sensor

Because the sensor we're using is digital, the Raspberry Pi and our code will need to manually load some drivers before being able to use the sensor. We need some information from this for our Python script. Wire up the sensor as shown in the diagram on the right. Connect the positive lead to pin 2, which is 3V3 power; connect the data wire to pin 36 (GPIO 16), and the ground to pin 34 next to it. Turn the Pi on.

### >STEP-02 Set up the sensor

Once booted up, open the terminal and do the following:

```
sudo nano /boot/config.txt
```

Add to the end of the file the line:

```
dtoverlay=w1-gpio,gpiopin=16
```

Reboot the Raspberry Pi and then open up the terminal again. We need to activate the relevant kernel modules with:

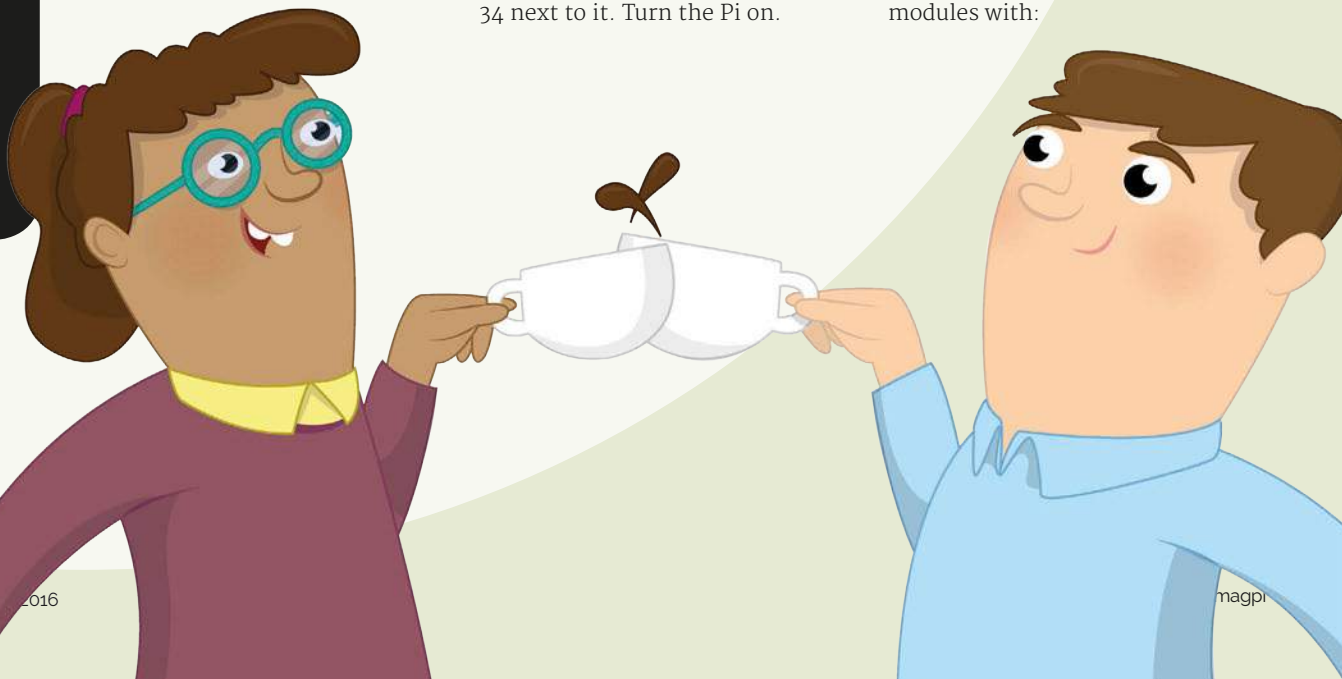



Language

>PYTHON

DOWNLOAD:  
magpi.cc/  
KettleSensor

Change the temperature on the fly to the correct one for your needs

This special temperature sensor will measure up to 125°C, even in water

See how the temperature is rising in your kettle with numbers and colours

## A GUIDE TO TEMPERATURE

What temperatures do you need to set your kettle alarm to? Here's a quick reference for general temperatures:

- White tea:** 65-70°C
- Green tea:** 75-80°C
- Coffee:** 80-85°C
- Herbal tea:** 90-95°C
- Black tea:** 95°C

This is why you pour milk **after** brewing, people!

You could also technically use this alarm for sous-vide cooking with an insulated drinks cooler. You'll have to check meat temperatures for that yourself, though.

```
sudo modprobe w1-gpio
sudo modprobe w1-therm
```

Now move into the w1 devices folder with `cd /sys/bus/w1/devices/` and use `ls` to list out what's there. It might take a few seconds to show up but a folder with something like **28-000006d85491** will appear. `cd` into the folder and type `cat w1_slave` to see if it returns date like so, which means it's working:

```
72 01 4b 46 7f ff 0e 10 57
: crc=57 YES
72 01 4b 46 7f ff 0e 10 57
t=22175
```

The `t` is the temperature in C (22.175). If something like this pops up, make a note of the folder name, you'll need it later.

### >STEP-03 Set up the display

You don't need the display plugged in for this, so you might as well install the libraries for it now, before we wire everything up. Use `cd ~` to go back to the home directory and install the Display-o-tron files with:

```
curl -sS get.pimoroni.com/
displayotron | bash
```

### >STEP-04 Wire up the full system

Reboot the Pi after installation, turn it off and unplug it so we can construct our system. Unplug the connection from the sensor to pin 2 and put the display in. Put this connection into pin 32 (GPIO 12) – it's not a 3V3 pin, but we're going to cheat to get it to power the sensor. Connect up the positive end of the buzzer to pin 40 (GPIO 21), and negative to pin 39.

### >STEP-05 Set up the code

Download the `temperature.py` code from [magpi.cc/KettleSensor](http://magpi.cc/KettleSensor). Remember the number we noted down earlier? This is the serial for the thermal sensor, and you'll need to edit line 19 in the Python file to replace **28-000006d85491**. While you're editing the file, you can also change the default temperature in `set_temp`.

Save and go back to the terminal, then use `sudo nano /etc/rc.local`. At the end of the file, add the following line so this script runs at boot (pointing towards where you saved the file):

```
python /home/pi/
temperature.py &
```

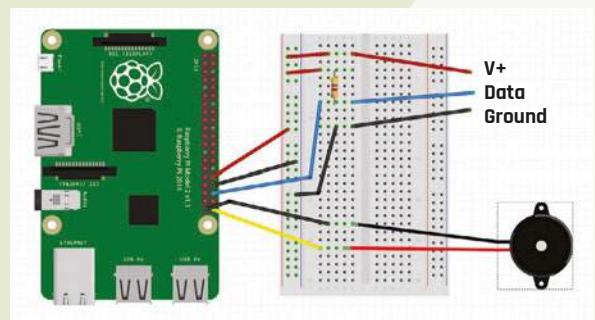
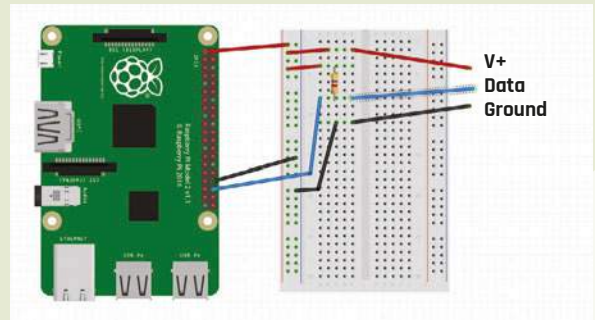

### >STEP-06 Use the sensor

You're ready to go! Test it out first in a cup of hot water to make sure it's all working – you may need to add `sleep.time(5)` to the script after line 17 if it doesn't load up. When placing it in your kettle, make absolutely sure the sensor doesn't touch the heating element – it will likely break it. Change the temperature on the fly using up and down on the joystick.

**Above top** Our initial circuit needs to make sure we have the thermal sensor's information

**Above** This is what the finished circuit looks like, minus the Display-o-tron. Technically, the buzzer can use the same ground rail as the sensor

# MAGIC MIRROR

## You'll Need

- Raspberry Pi Model 2 or 3
- USB WiFi module
- Ribba picture frame 40x50cm – IKEA
- One-way mirror film
- LCD VGA monitor
- HDMI-to-VGA adapter
- SkyWriter HAT [magpi.cc/10APeHb](http://magpi.cc/10APeHb)
- Connectors and leads

After making sure you look your best in the morning, catch up on the world around you with a flick of your wrist. **Mike Cook** shows us how...

**T**here are many different types of 'magic mirror'; they consist of a computer display hidden behind a partially reflective surface that's invisible until the display lights up, masquerading as a normal mirror in the meantime. This particular design is for a web browser controlled through

gestures, using Pimoroni's Skywriter HAT sensor board. This 65x55mm board uses near-field RF disturbances to recognise gestures, and these gestures can be used to control a web browser hidden in the Magic Mirror. We got it to use a 'getting to work' checklist from a variety of sites from the BBC: news headlines, national weather, local weather, and local road reports. But it's easy to define your own group of webpages around any theme that takes your interest.

### THE PROJECT

The basic list of webpages is stored in a normal text file called **sites.txt**, with one line for the URL of each page. The Python script will take this file and set up the web browser with a tab for each URL. Communication between Python and the web browser is done by the PyAutoGUI framework. This is a clever system of inserting mouse clicks

and typing into any application running on the desktop. Once the browser is set up with all the pages you want to view, the Skywriter sensor looks for gestures and then uses them to control the web browser. For example, a flick left or right displays the page in the next tab. A flick up or down scrolls the contents of the webpage up or down. The air wheel gesture, a rotating finger, refreshes the webpages on all the tabs. Finally, a double tap will shut the system down, allowing you to safely remove the power without fear of damaging the SD card. The Skywriter has a few other gestures in its repertoire that we don't use here, so you might like to extend control using these.

Unfortunately, electric field sensors like the Skywriter won't work through mirror film (we tried), because the metal content shields the electric field, therefore the sensor has to be mounted on the mirror's frame.





## THE HARDWARE

The hardware is just a Raspberry Pi set up for web browsing, so that means it must have access to the internet and some sort of display. While you can use any display, we took the opportunity to use an old LCD VGA monitor, rescued at the last moment from going into landfill; this requires an HDMI-to-VGA adapter for the Pi to drive it. We took the back off the LCD VGA, nicely removing the mount at the same time, and mounted it inside an IKEA picture frame. While a lot of the detail will depend on the mechanical construction of your monitor, see the step-by-step section overleaf for what we did. Web browsing is not the slickest of pastimes on a Pi, so we recommend using a Model 2 or 3 with the latest fast browser, which is currently Epiphany.

## THE SOFTWARE

First off, you need to install the PyAutoGUI framework and the Skywriter library.

**Below** The whole system needs to be secured properly in place – with luck, you'll never have to see it again

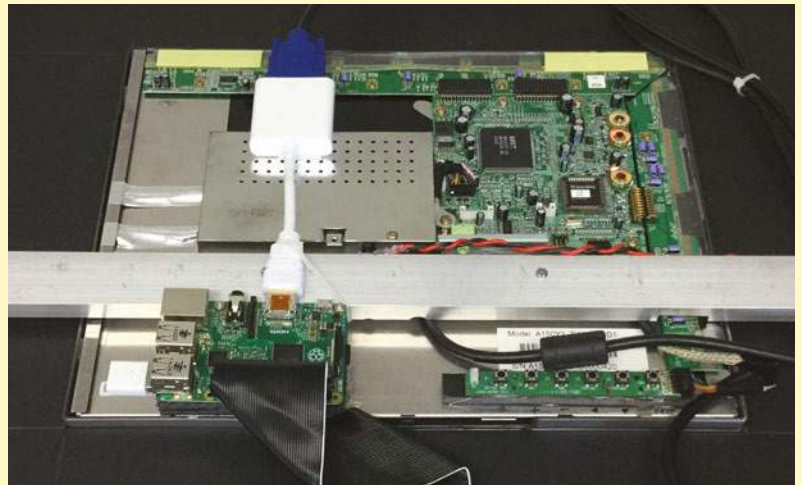

For PyAutoGUI, you'll need to use:

```
sudo apt-get update
sudo apt-get install
python-xlib
sudo pip install pyautogui
```

And for the Skywriter, follow the advice at [magpi.cc/22s5Md6](http://magpi.cc/22s5Md6).

The PyAutoGUI framework works on absolute mouse coordinates. It knows little of what window is where – it just positions the mouse at given coordinates and can click, drag or write. This means in order for it to do its magic, you have to be organised and know where the window and the sweet spots (URL links and tabs) are going to be. These points will be different on different screen resolutions, so you must gather these magic numbers for your own setup and replace the ones we used on ours at the start of the Python script. To help you do this, there's a mouse monitor program called **mouseMon.py** (overleaf). It simply prints out the coordinates of where the mouse is currently. Run this from IDLE and make a note of the numbers you get for each point the main **webDriver.py** program requires, as detailed below.

## CONTROLLING THE BROWSER

The code in **webDriver.py**, which can be downloaded or copied from the listing overleaf, drives the browser. Basically, it sets up the browser by clicking on the icon on the top row of the screen, then it clicks on the URL space and types in the first URL from the **sites.txt** list. The rest of the list is read and a new tab opened for each one. Make sure there aren't

Replace author Mike Cook with yourself and you get the idea of what it would be like to use it

A custom collection of URLs in this version allows you to quickly create a series of relevant pages for yourself

Your day at a glance, but only when you want it to show up by activating it

Skip through the data with a simple swiping gesture over the Skywriter

too many tabs so that the tab bar has to be scrolled, as you have no control of tab bar scrolling with this code. When it was all finished and tested, we changed the `/etc/rc.local` file to add this line to the end:

```
python "path name"/
webDrive.py &
```

This makes the Pi boot up automatically into this program. Of course, the "path name" should be replaced by the path where this program is to be found.

**MIRROR UPGRADES**

If you fancy making your magic mirror look more like a mirror when you actually start using it, then you might want to refer to Michael Teeuw's Magic Mirror code up on GitHub: [magpi.cc/1U1beIQ](http://magpi.cc/1U1beIQ). It creates a custom interface using a black screen and white text to make the whole setup look like a mirror, but with extra info on it. This could be particularly useful if you have a larger monitor or even an old TV you want to use for the project.

With a bit of tweaking and modification, you can have it scrape data from the sites you listed and even have it swipe between the different bits of information, to keep the mirror from being overwhelmed with data all at once. How you make and use your mirror is all up to you and your personal tastes.

*mouseMon.py*

```
#!/usr/bin/env python
import pyautogui, sys,
time
print('Press Ctrl-C to
quit.')
```

print " screen size ",
pyautogui.size()
try:
 while True:
 x, y = pyautogui.
position()
 positionStr = 'X:
' + str(x).rjust(4) + ' Y:
' + str(y).rjust(4)
 print positionStr,
 print '\b' \* (
len(positionStr) + 2)
 sys.stdout.flush()
 time.sleep(0.5)
except KeyboardInterrupt:
 print '\n'

*webDriver.py*

```
#!/usr/bin/env python

import time
import random
import os, sys
import RPi.GPIO as GPIO
GPIO.setwarnings(False)
import pyautogui
import skywriter
import signal

# location in screen to click
# on a 1024 X 768 VGA monitor
browserIcon = (112,19)
newTab = (957,80)
refreshPage = (912,80)
typeURL = (697,80);
tabBar = 118
tabOffset = 105
tabIncrement = 200

sitesfile = open("sites.txt","r")
sites = list()
numberOfPages = 0
for line in sitesfile.readlines():
    sites.append(line)
    numberOfPages +=1
sitesfile.close()
numberOfPages -=1
increment = 0
scroll = 0
visited = 0
air_value = 0

def main():
```

**MAKING THE MAGIC MIRROR**

**>STEP-01**  
Prepare the monitor



With the back off the VGA monitor, it revealed two short tapped pillars. We extended these with a 10mm M3 tapped pillar, fastened with a piece of M3 studding or thread cut from a longer bolt. This was the basic anchor for the system. It was fastened to a length of 30x12 aluminium channel of 3mm thickness that spanned the whole width of the frame. The channel walls were trimmed to fit flat.

**>STEP-02**  
Fixing the bar



At each end, a piece of 20mm angled aluminium was mounted so that it could be bolted onto the frame with two M3 bolts. Holes in the top were used to fasten this to the long channel to make a secure fit. We found it a bit fiddly to hold the nuts on the underside of these right-angled brackets, so we fastened them on the underside with hot-melt glue to allow easy assembly and disassembly.

**>STEP-03**  
Allowing cable access



Slots were cut in the wall of the channel to allow cables to pass through, and also allow clearance for some components on a side board. Don't cut too deep or you'll start weakening the beam somewhat – in the long run, that would be bad for the overall structural strength of the mirror, and that wouldn't make your life easier in the way we want.



```

global increment,numberOfPages, visited, scroll,
air_value
def setupBrowser():
    print "number of pages in the file ",numberOfPages
    while True :
        while increment == 0 and scroll == 0 and air_value <
500:
            time.sleep(0.5)
            if increment != 0 :
                showNewTab()
            if scroll !=0 :
                scrollPage()
            if air_value >=500:
                refreshAll()

def refreshAll():
    global air_value
    for page in range(0,numberOfPages):
        xClick = tabOffset + (tabIncrement * page)
        pyautogui.click(x=xClick,y=tabBar)
        time.sleep(0.4)
        pyautogui.click(x=refreshPage[0],y=refreshPage[1])
        time.sleep(0.8)
    air_value = 0

def scrollPage():
    global scroll
    screenWidth, screenHeight = pyautogui.size()
    pyautogui.moveTo(screenWidth/2, screenHeight /2)
    time.sleep(0.2)
    pyautogui.scroll(scroll * 5)
    print"scroll ",scroll
    scroll = 0

def showNewTab():
    global increment, visited

```

```

        visited += increment
        if visited >=
numberOfPages :
            visited = 0
        if visited < 0 :
            visited =
numberOfPages -1
            increment = 0
            # click on the appropriate tab
            xClick = tabOffset + (
tabIncrement * visited)
            print"tab ",visited," location ",xClick
            pyautogui.click(x=xClick,y=tabBar)

def setupBrowser():
    global numberOfPages
    pyautogui.doubleClick(
x=browserIcon[0],y=browserIcon[1])
    time.sleep(3.0) # let the browser open

    pyautogui.click(
x=typeURL[0],y=typeURL[1])
    pyautogui.typewrite(
sites[0]+"\\n", interval= 0.0)
    time.sleep(1.0)
    for page in range(1,numberOfPages):
        pyautogui.click(
x=newTab[0],y=newTab[1])
        pyautogui.click(x=typeURL[0],y=
typeURL[1])
        time.sleep(0.5)
        print " opening up ",sites[page]
        pyautogui.typewrite(
sites[page]+"\\n", interval= 0.0)
        time.sleep(1.0)
        pyautogui.click(x=tabOffset,y=tabBar)

```

Language

>PYTHON 2.7

DOWNLOAD:  
magpi.cc/1NqJjmV

```

@skywriter.flick()
def flick(start,finish):
    global increment, scroll
    print("Got a sensor flick!", start,
finish)
    if start == "east" and finish == "west":
        increment = -1
    if start == "west" and finish == "east" :
        increment = 1
    if start == "north" and finish == "south":
        scroll = -1
    if start == "south" and finish == "north"
:
        scroll = 1

@skywriter.airwheel()
def spinny(delta):
    global air_value
    air_value += abs(delta)
    print("Airwheel:", air_value)

@skywriter.double_tap()
def doubletap(position):
    print"Double tap! closing down"
    os.system("sudo shutdown -h now")

if __name__ == '__main__':
    main()

```

## >STEP-04 Monitor controls



The monitor's control buttons were removed from the front panel and hot-melt-glued on a piece of foam mounted to the back of the monitor. Then the control panel mount was removed by careful use of a knife; the monitor's shape was a clean rectangle and the mounting foam for the surrounding was a lot easier to cut. The surrounding mount was cut from black A3 foam in two pieces.

## >STEP-05 Finishing off



The Skywriter HAT was mounted on a Black HAT Hack3r extension board and fastened to the underside of the frame. You could just use a 40-way female-to-male ribbon cable if you want, but make sure the HAT is connected to the correct pins if you're doing this. Fit the frame glass with mirror film. Unfortunately, the Skywriter doesn't work from behind this film, which is why it's on the side.

# TEDDY BABY MONITOR

## You'll Need

- Raspbian Jessie (make sure it's up to date) [magpi.cc/1U7aNgf](http://magpi.cc/1U7aNgf)
- Raspberry Pi Camera Module [magpi.cc/1UaFuUW](http://magpi.cc/1UaFuUW)
- RPi Cam Web Interface [magpi.cc/1RhjyYU](http://magpi.cc/1RhjyYU)
- Stuffed toy. We're using one with a shirt for easier camouflage

A camouflaged security camera – perfect for keeping an eye on a baby from another room, or covertly making sure no one's nicked your stuff when you're away from home

**S**ecret stuffed toy cameras are either a weird movie cliché or a very smart way to keep an eye on certain things. Either way, proprietary products are going to be expensive; with a Raspberry Pi and any stuffed toy, you can create as good a product as any bought one. As well as childcare, it can be a good camouflaged CCTV camera in case of burglaries, and you'll be able to view it on any web browser.

### SELECTING YOUR RASPBERRY PI

Before we start constructing our teddy camera, it's best to get the Raspberry Pi ready for the task. We've selected a Model A+ for this project, as it's quite small yet still supports the Camera Module. It also runs the web-streaming software

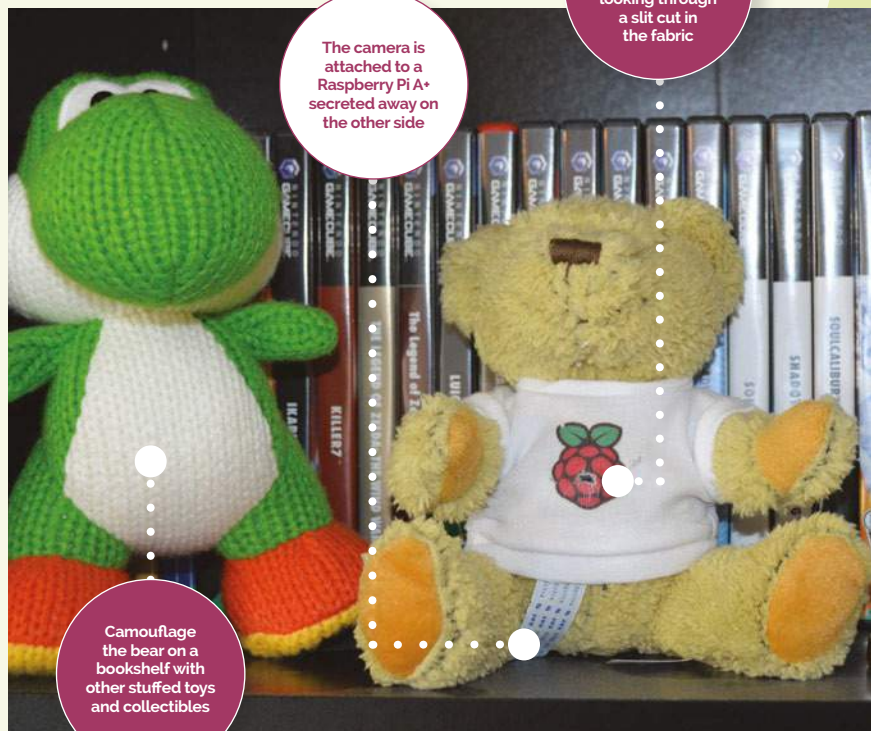

The camera is attached to a Raspberry Pi A+ secreted away on the other side

Peeking through the shirt is the Camera Module, looking through a slit cut in the fabric

Camouflage the bear on a bookshelf with other stuffed toys and collectibles



**Below** Make sure the Camera Module is activated in the settings

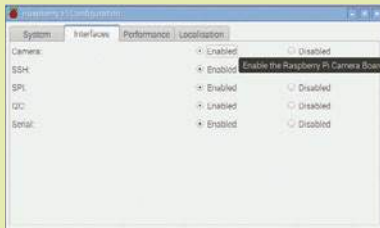

fine; considering all the finished project requires is power and a wireless LAN connection, it makes the A+ a perfect candidate Pi.

As we're making this wireless, it's best to get that set up now – unless you plan to run a Cat 6 cable up to a stuffed toy, which might ruin the camouflaging effect. You'll also want to go into the Configuration menu in Menu> Preferences and enable the camera in the Interfaces tab, then reboot.

## INSTALLING THE SOFTWARE

We're using the tried-and-tested RPi Cam Web Interface software for this tutorial, which connects straight to the Raspberry Pi Camera Module and displays it in a pre-made web interface that's all part of the package. Open the terminal and clone the project's GitHub repo with the following command:

```
git clone https://github.com/silvanmelchior/RPi_Cam_Web_Interface.git
```

It's not a big repo, so it shouldn't take too long to download. Once it's done, move into it and make all the relevant files executable using the following command:

```
cd RPi_Cam_Web_Interface
chmod u+x *.sh
```

It's now ready to be installed, which you can do simply with:

```
./RPi_Cam_Web_Interface_Installer.sh install
```

The whole process will take a little while to install; you may wish to perform it on a newer Pi if possible. You'll also be asked a few

questions along the way – the first will be whether or not you want to install Apache. This is the web server software you'll need to actually view the camera in a web browser, so press **Enter** to confirm you wish to do so. Towards the end of the installation, it will ask where you want to put the default web root folder; you can just press **Enter** to accept the default, but if you know what you're doing you can create a custom one.

Once it's all finished, the install script will throw up one final prompt on whether or not you wish to reboot – select Yes.

## FIRST TESTS

After the reboot, the light on your Camera Module should have turned on. If you've not plugged the Camera Module in yet, turn off the Raspberry Pi and do so; pull up the plastic slide between the audio and HDMI port, insert the ribbon with its silver stripes facing the HDMI port, and then securely push the slide down. Now turn the Pi back on.

The light activates on the Pi camera to show it's on. To see if the web interface is all working, open the browser and navigate to your Raspberry Pi's IP address. If you don't know what that is, open up the terminal and type **ifconfig** to bring it up. It will be listed as 'inet addr' and look something like 192.168.1.50.

## FINISHING UP

If everything's working (and before connecting it to Babbage, as shown in the steps), we can do some housekeeping. If you have to manually start it every time, then add a command to **rc.local**

# TURN BABBAGE INTO A CAMERA

## >STEP-01

### Cut the camera hole

Press the Camera Module up against the shirt. Mark out the size of the aperture, then cut it open (carefully!) with a good craft knife.



## >STEP-02

### Attach the camera

Make sure the camera aperture has enough space to see through the hole and then sew the mounting points of the module to the shirt.



## >STEP-03

### Attach the Pi

Loop the camera cable under the teddy. Attach the Pi (A+ is best) to the back with the same sewing method, and then connect the ribbon cable.



to get it to launch at boot. It's also a good idea to go to Raspberry Pi Configuration and have it boot to the CLI; this means it will turn on a bit faster and use less power, as you won't need to use the graphical interface with this Pi. You'll still be able to dial in via SSH, though, for any maintenance.

Turn it all off, remove all unnecessary cables (HDMI, mouse, keyboard) and you can finally move onto the steps on how to construct the camera. Once that's done, find a good place near a power socket and you're done!



# TWITTER CONTROLLED HAMSTER FEEDER

## You'll Need

- > NPN transistor [magpi.cc/1SYoE0x](http://magpi.cc/1SYoE0x)
- > Motor with worm gear [magpi.cc/1Rr1JWL](http://magpi.cc/1Rr1JWL)
- > Assorted junk from recycling bins, toy boxes, charity shops, etc.

Treat your hamster (or other family rodent) to a tasty seedy snack with a simple tweet – great when you're working late or don't want to get up. **Ben Rogers** shows you how...

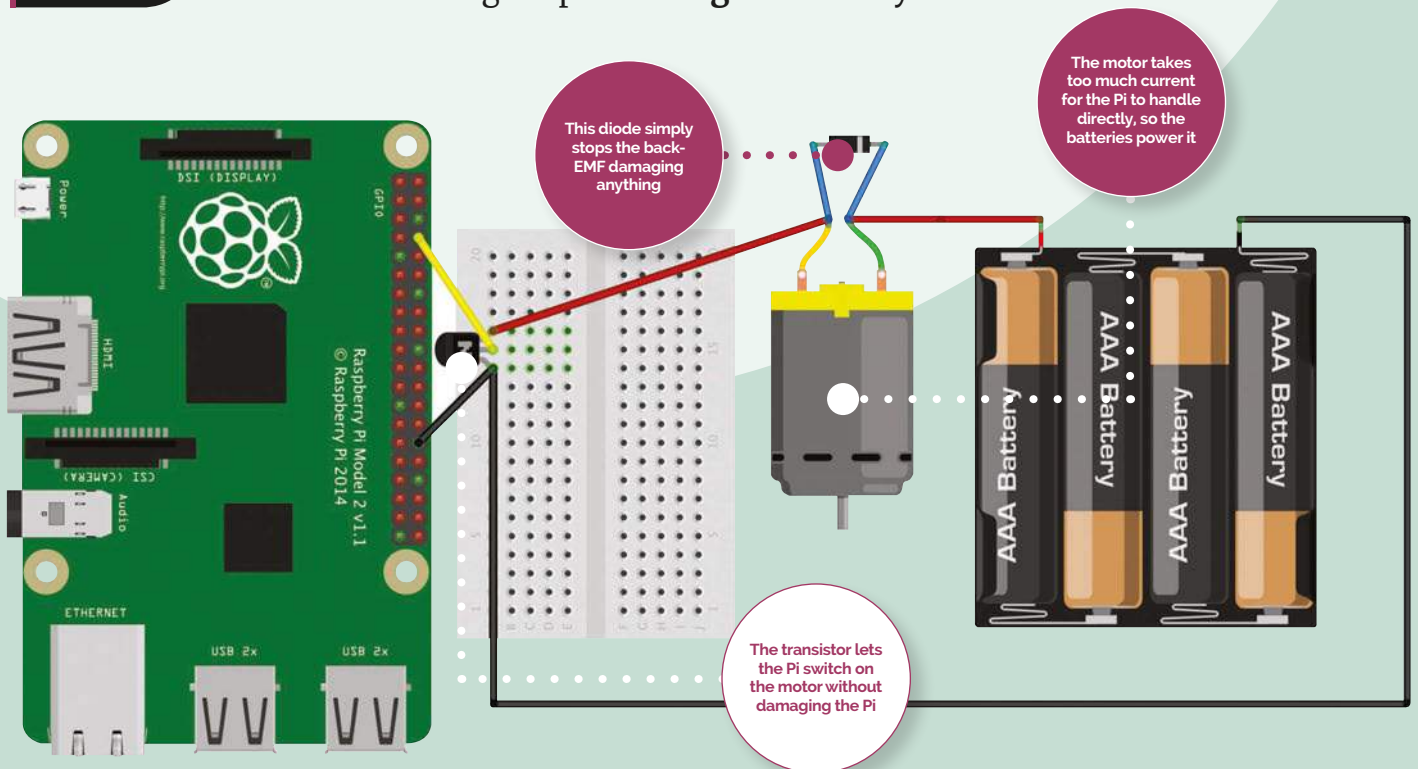



**H**ave you ever found yourself far from home, wishing you could give your pet hamster a little treat to show how much you care? It's a common problem, but it need never be an issue again. With a Raspberry Pi running Node-RED, an open collector to drive a motor, some enjoyable engineering tinkering, seeds, and a hamster, you can build a Twitter-controlled Hamster Feeder of your own.

**>STEP-01**  
Install Node-RED on your Pi

If you have the latest version of Raspbian Jessie, Node-RED comes installed in your Programming folder. If not, you can install it via a terminal (see [magpi.cc/1VuU5Aq](http://magpi.cc/1VuU5Aq)).

**TWITTER-CONTROLLED MOTORS**



Now that we have the open collector circuit working, we can use it to power motors to do any number of things. A possible next project includes a model volcano with a computer cooling fan inside. The fan blows red tissue paper streamers in the air every time #volcano is used on Twitter – very useful if you live next to one. The prototype fan is strong enough to blow a small polystyrene ball into the air, which has been painted grey to look like an asteroid. This is now an asteroid alert system, which switches on every time #asteroid is mentioned on Twitter. Hopefully, #aurora and #earthquake alerts will be added shortly.

You also need the Iceweasel browser. Connect your Pi to the internet, open Node-RED, and paste the address at the top of the Node-RED window into Iceweasel. You should now see the Node-RED editor.

**>STEP-02**  
Node-RED listening to Twitter

Drag the Twitter node with the connector on the right into the work area. Double-click on it and enter your Twitter ID. You need to search 'all public tweets' – unless you want to ensure only you can feed your hamster! Add your search term: #feedmyhamster. When someone tweets a message including '#feedmyhamster', the Twitter node receives the message and passes it on to the next node.

**>STEP-03**  
Turn the motor on (and off).

The message that comes out of the Twitter node has all of the tweet metadata, but you just want the message to be 1 to turn on the GPIO pin, so add the change node and change the message to 1. Add the delay with a change message to 0 to turn the GPIO back off. Finally, connect both to the GPIO out node. Set the pin to your output pin. Don't forget to deploy your Node-RED flow.

**>STEP-04**  
Connect the motor

If you tried to power the motor directly by the GPIO, the current would damage the Pi. Instead, use an open collector transistor. The transistor switches the motor on when the GPIO pin is set to high.

**Below** The overall layout, showing the Archimedes screw and hopper with motor and gears

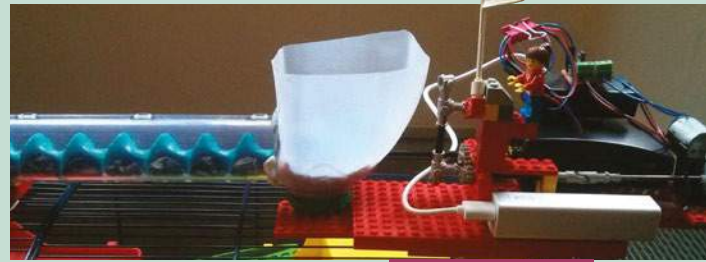

As our motor still runs too fast, we used technical Lego gearing to reduce the speed.

**>STEP-05**  
The engineering

An Archimedes screw from a marble-run game has been used to deliver the sunflower seeds. The hopper was made from a plastic milk bottle. Another successful (but not as cool) prototype involved a disc made from several layers of card, with a seed-sized notch in it. The disc is half-inside and half-outside the bottom of the hopper. As the disc rotates, the notch catches a seed at the top and drops it into the cage, half a turn later.

**>STEP-06**  
Happy hamster!

Now, whenever anyone in the world uses the hashtag '#feedmyhamster', the Raspberry Pi gets the message and converts it to an on signal. It passes this signal to the GPIO. The GPIO feeds an on signal to the transistor, which then lets a current flow to the motor. The motor turns the gears, which turn the Archimedes screw, delivering a couple of seeds into the cage. No hamsters were harmed (or overfed) in the making of this project.

Language  
>NODE-RED  
DOWNLOAD:  
[magpi.cc/HamsterFeeder](http://magpi.cc/HamsterFeeder)



# HOME MEDIA SUITE

## You'll Need

- Two Raspberry Pis, one with up-to-date Raspbian (check the FAQ) [magpi.cc/1U7aNqf](http://magpi.cc/1U7aNqf)
- OpenELEC [openelec.tv](http://openelec.tv)
- USB hard drive
- Usual selection of cables for your TV

Make your media consumption easier by creating a media server and media centre, so you can truly relax after a hard day

Relax with your favourite film streamed straight from your media server

**M**edia centres on Raspberry Pi – easy, right? Just install OpenELEC and you're done. Plugging in USB storage, disk drives and the like makes the setup a little unsightly under your TV, though. This is

where a good media server comes in, allowing you to keep all your media in one place without the need to go between shelves and the TV. Just sit down, pick up the remote, and take it easy for the evening.

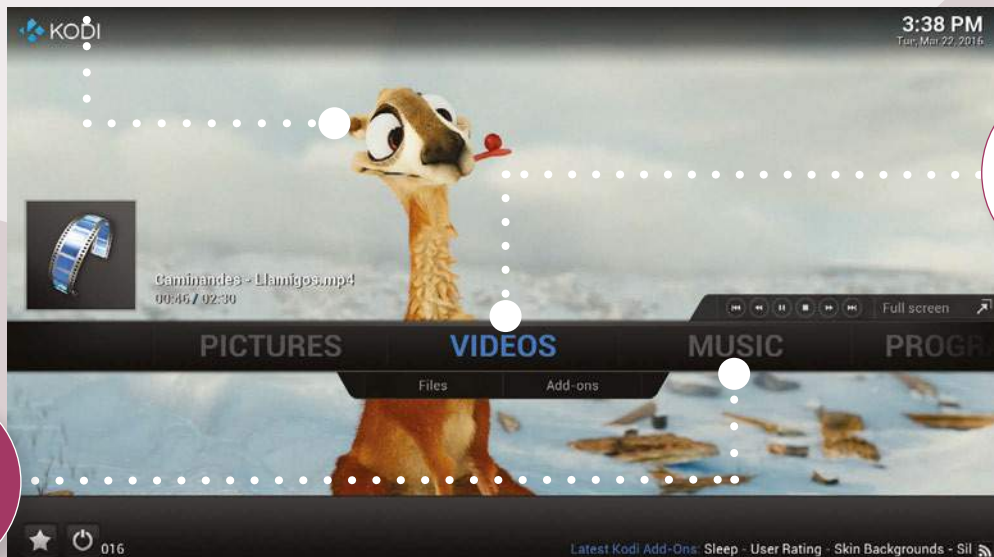

The standard Kodi dashboard is used to navigate and choose media to stream

Stream any track you like from your complete music collection, stored on a hard drive



## NETWORK DISC DRIVES



We haven't covered it here, but one interesting thing you could try is attaching a USB optical disc drive to your media server Pi and sharing the disc over the network. This share can be picked up by Kodi and you'll be able to play over the network. You can then place this media server with all your films and TV box sets to make putting them in easier. Unfortunately, Blu-ray drives are still a bit tricky to get working on the Raspberry Pi, if at all, so you'd be limited to DVD.

### >STEP-01 Server Pi setup

For the server Raspberry Pi, you can get away with using just about any Pi for the task. As all the hard work will be done on the TV Pi, all you need is a place that can store and transfer the files over the network. We'd suggest at least a B, though, as the extra USB ports will allow you to easily put in at least one USB drive and a WiFi dongle if you want to make it wireless. Install and update Raspbian and we're ready to go.

### >STEP-02 Network sharing

To make this very easy, create a folder called **share** in the home directory. We'll make sure all our media is mounted into here. We need to install Samba for this – go to the terminal and install it all with:

```
sudo apt-get install samba
samba-common-bin
```

Open up the Samba configuration file with `sudo nano /etc/samba/smb.conf` and make sure the following settings look like this:

```
workgroup = WORKGROUP
wins support = yes
```

### >STEP-03 Share folder

Our share folder is called 'share' and lives in `/home/pi/share`. In the same configuration file for Samba, add the following to the end of the file and save:

```
[MediaServer]
comment=Raspberry Pi Media
Server
path=/home/pi/share
browseable=Yes
writeable=Yes
only guest=no
create mask=0777
directory mask=0777
public=yes
```

### >STEP-04 Auto-mounting storage

This is the clever bit – how do we get the media into the share folder? You could manually mount the main storage hard drive to the folder, but if you add other USB storage devices (or a USB disk drive), they won't show up. You could share the media folder, but we're going to use `fstab` to mount it into the share folder. In the terminal, use `sudo nano /etc/fstab` and add the line:

```
/media/ /home/pi/share none
defaults,bind 0 0
```

### >STEP-05 TV Pi setup

We're using OpenELEC for this setup, but you're free to use OSMC or another Kodi alternative. We also suggest you use a Raspberry Pi 2 or 3 for the media centre; while a



generation 1 Pi will handle Kodi and high-def videos, it's not uncommon to experience a bit of interface lag. The Pi 2 and 3 have a bit more power to deal with that.

**Above** It's quick and easy to add shares to Kodi to then browse and stream

### >STEP-06 Network shares

Go to Video (or Music) on your Kodi dashboard and click on 'Add Videos...'. Scroll down to Windows network (SMB) and select it. It should search the network and give you the WORKGROUP option. In there you'll find RASPBERRYPI, which has a MediaServer folder inside it. Select OK, give it a name you want, then press OK again and it should be added! All the files will be in the USB folders within the share for to peruse as you please.

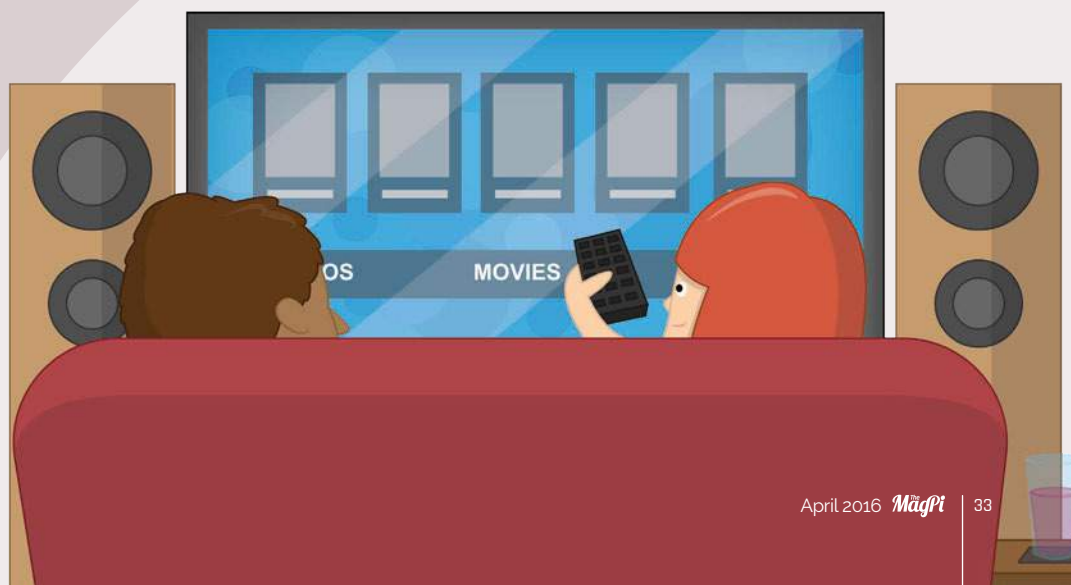

# SUBSCRIBE TODAY!

Subscribe to the Official Raspberry Pi mag today for a whole host of benefits

## Subscription benefits

- Save up to 25% on the price
- Free delivery to your door
- Never miss a single issue
- Get it first (before stores)

**PI ZERO  
#40 IS STILL  
ON OFFER  
Call today!**

SAVE  
UP TO  
**25%**





# SUBSCRIPTION FORM

YES! I'd like to subscribe to The MagPi magazine & save money

This subscription is:  For me  A gift for someone\*

Mag#44

## Pricing

Get six issues:

£30 (UK)

£45 (EU)

\$69 (USA)

£50 (Rest of World)

Subscribe for a year:

£55 (UK)

£80 (EU)

\$129 (USA)

£90 (Rest of World)

Direct Debit

£12.99 (UK) (quarterly)

**YOUR DETAILS** Mr  Mrs  Miss  Ms

First name ..... Surname .....

Address .....

Postcode ..... Email .....

Daytime phone ..... Mobile .....

*\*If giving The MagPi as a gift, please complete both your own details (above) and the recipient's (below).*

**GIFT RECIPIENT'S DETAILS ONLY** Mr  Mrs  Miss  Ms

First name ..... Surname .....

Address .....

Postcode ..... Email .....

### PAYMENT OPTIONS

**1 DIRECT DEBIT PAYMENT** £12.99 every 3 issues (UK only)  
Instruction to your bank or building society to pay by Direct Debit



Please fill in the form and send to:

The MagPi, Select Publisher Services Ltd, PO Box 6337, Bournemouth BH1 9EH Service user number 8 3 8 7 7 3

Name and full postal address of your bank or building society:

To: The Manager Bank/building society .....

Address .....

Postcode .....

Name(s) of account holder(s) .....

Branch sort code  Account number

Reference  (Official use only)

**Instruction to your bank or building society**

Please pay Select Publisher Services Ltd Direct Debits from the account detailed in this instruction subject to the safeguards assured by the Direct Debit Guarantee. I understand that this instruction may remain with Select Publisher Services Ltd and, if so, details will be passed electronically to my bank/building society.

Signature ..... Date  /  /

Banks and building societies may not accept Direct Debit instructions for some types of account.

### SUBSCRIPTION PRICING WHEN PAYING BY CHEQUE OR CREDIT/DEBIT CARD

6 ISSUES  UK £30  Europe £45  Rest of world £50

12 ISSUES  UK £55  Europe £80  Rest of world £90

### 2 CHEQUE

I enclose a cheque for ..... (made payable to Select Publisher Services Ltd)

### 3 CREDIT/DEBIT CARD

 Visa  MasterCard  Maestro  Switch

Card number

Expiry date  /  Valid from  /  (if shown)

Issue number  (if shown) Security number  (last 3 digits on the back of the card)

Signature ..... Date  /  /

I would like my subscription to begin from issue ..... (month + year)

### RETURN THIS FORM TO:

MagPi Magazine Subscriptions, Select Publisher Services Ltd, PO Box 6337, Bournemouth BH1 9EH

Please tick this box if you DO NOT want to receive any other information from Select Publisher Services Ltd.

Please tick this box if you DO NOT want to receive any other information from other companies.

Please tick this box if you DO NOT want to subscribe to The MagPi newsletter.

## How to subscribe:

- [magpi.cc/Subs1](http://magpi.cc/Subs1) (UK / ROW)
- [imsnews.com/magpi](http://imsnews.com/magpi) (USA)
- Call +44(0)1202 586848 (UK/ROW)
- Call 800 428 3003 (USA)





TIBURCIO DE LA CARCOVA

Tiburcio is the founder of STGO Makerspace in Santiago, Chile, and organised the first Maker Faire in Latin America.  
[magpi.cc/1V8XEvY](http://magpi.cc/1V8XEvY)

# GALAGA PI

This Galaga Mini Arcade is a flawlessly detailed recreation of a fantastic arcade machine, with a Raspberry Pi at its core. We caught up with **Tiburcio de la Carcova** to talk about it

## Quick Facts

- ▶ It took Tiburcio two months to build the project
- ▶ The joystick is 3D printed but the buttons are pre-built
- ▶ Tiburcio is planning to build 25 arcade machines in total
- ▶ It even has a 3D printed coin door
- ▶ It is approximately 1:4 scale of the original

“I love arcade and pinball machines,” enthuses Tiburcio. “I love to buy and restore them, but I was running out of space and my wife was running out of patience.”

Most people would buy an old arcade machine, or perhaps place a Raspberry Pi inside a full-size cabinet, but Tiburcio had grander ideas: “I decided to build a collection of scale arcade machines.”

One quick look at the photos will show you he succeeded, but Tiburcio isn’t an amateur maker by any means. Originally from Buenos Aires, Argentina, Tiburcio was the founder of STGO Makerspace ([stgomakerspace.com](http://stgomakerspace.com)) and organised the first Maker Faire in Latin America.

“My first try was in 2013,” he says. “I made a scaled version of *Space Invaders*, which was particularly complex because it uses a double mirror. *Galaga* was one of my favourite arcade games, so it came next. It’s an accurate scale replica of the original arcade, mostly custom-made, and it uses a mini CRT which makes it unique. You need a CRT to get the real arcade feel.

“Finding the right screen was a challenge. There are not many colour 5” CRTs. I usually get them from old broadcast TV monitors or cheap portable TVs. This particular screen is a Magnavox portable TV.”

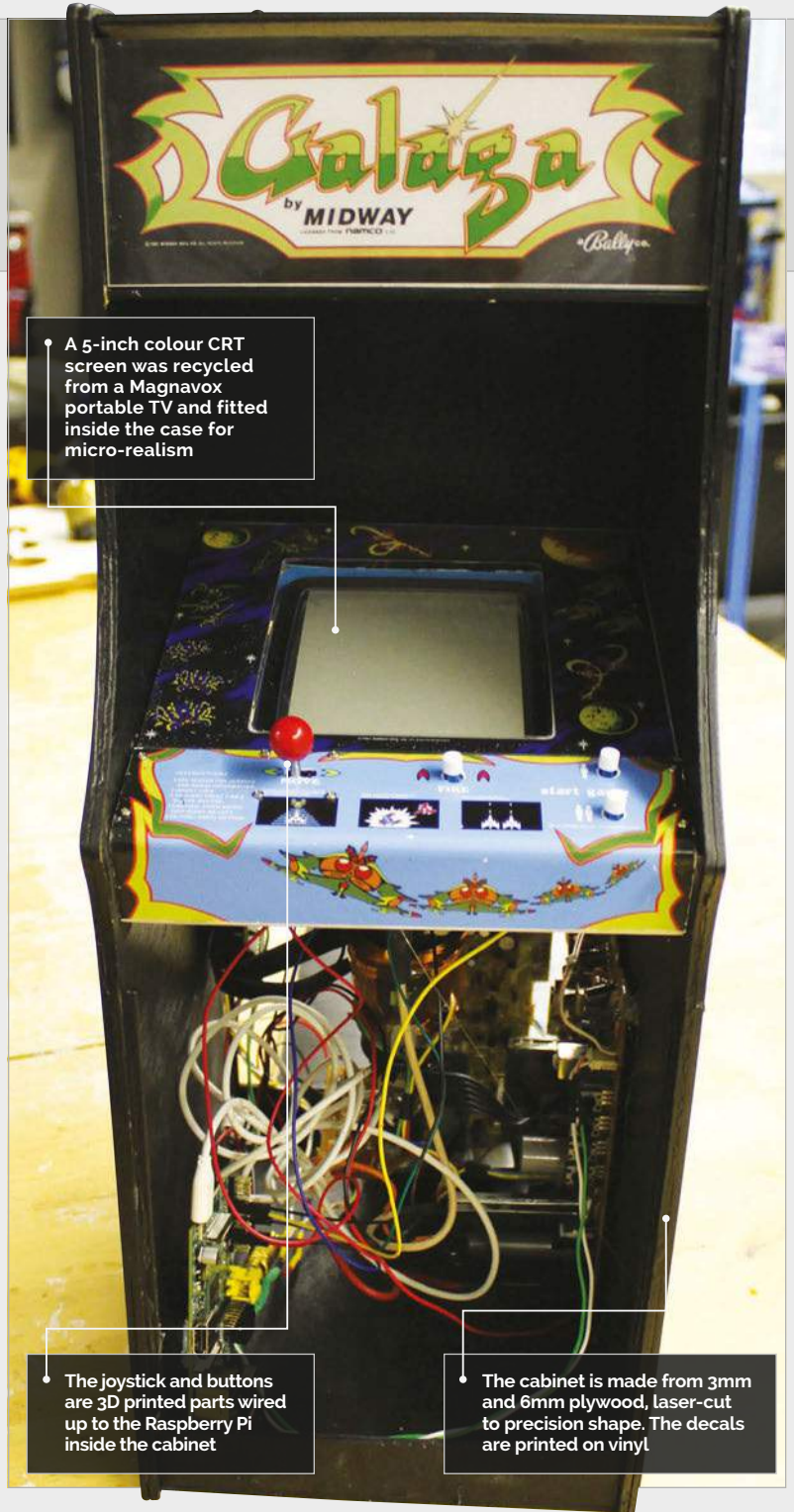

A 5-inch colour CRT screen was recycled from a Magnavox portable TV and fitted inside the case for micro-realism

The joystick and buttons are 3D printed parts wired up to the Raspberry Pi inside the cabinet

The cabinet is made from 3mm and 6mm plywood, laser-cut to precision shape. The decals are printed on vinyl



Tiburcio has made several miniature replicas of his favourite arcade machines



The scale cabinet was made from 3mm and 6mm plywood, with the parts modelled in Sketchup ([sketchup.com](http://sketchup.com)) and laser-cut. The rest of the cabinet was custom-constructed using 3D printed models, acrylic, and aluminium.

Aside from the Raspberry Pi and screen, pretty much everything is built from scratch. “The decals are from online repositories,” says Tiburcio. “I scaled to fit and printed them with a photo printer

scale that looked accurate. I started with a model I found at Thingiverse ([thingiverse.com](http://thingiverse.com)) and improved [it] with a metal stick and a spring system.

“You can find most of the original artwork online,” continues Tiburcio. “There are many repositories with vector and bitmap versions of the artwork. Sometimes the colour is not accurate, and you need to make some adjustments, but most of the time it’s just about scaling them.”

“It’s an accurate scale replica of the original arcade, mostly custom-made, and it uses a mini CRT”

on vinyl. If I needed to make more accurate stencils, I would use vinyl and a Silhouette Cameo ([silhouettecameo.co.uk](http://silhouettecameo.co.uk)) cutter.”

The push buttons were bought ready-made, but the joystick is 100% 3D printed: “I started with a model online and improved it with a spring and metal stick.”

Even the coin door is 3D printed, with a little metal rod that goes across the hinge. “I own some real arcade machines,” he explains, “so with those as the reference, I modelled the door and printed it.

“The joystick was a challenge, since there’s no joystick of that

Original arcade cabinets were painted with stencils using layers of three or four colours. So Tiburcio applied a clear coat base over his decal to make it look like paint.

“It plays well,” he tells us. “Correctly nailing the joystick was the key to making it good. The microswitches in the push buttons are not as smooth as an arcade, but it works. The plan is to build a collection of my 25 favourite machines. I’m currently making *Pac-Man*, *Donkey Kong*, *Missile Command*, and *Asteroids* (which is an even bigger challenge since it has a vector CRT).”

## BUILDING A MINI ARCADE CABINET



### >STEP-01

#### The cabinet

The cabinet is built from plywood and laser-cut into shapes. A 5-inch CRT monitor is fitted into the assembled parts, and vinyl decals are used to decorate the box.



### >STEP-02

#### Raspberry Pi

At the heart of the machine is an original Raspberry Pi running AdvanceMAME ([www.advancemame.it](http://www.advancemame.it)). It is set up to boot directly into the *Galaga* ROM.



### >STEP-03

#### All lit up

An LED strip is placed behind the cabinet’s *Galaga* logo to light it up, and the whole unit is powered by a 12V power supply hacked to provide 5V to the Raspberry Pi.





**DR PAUL BUCKLEY**

Dr Paul is a retired doctor who has taken up small-scale farming. His North Yorkshire farm has four Shire horses trained to work a flock of around 150 sheep.  
[magpi.cc/1TeDkcO](http://magpi.cc/1TeDkcO)

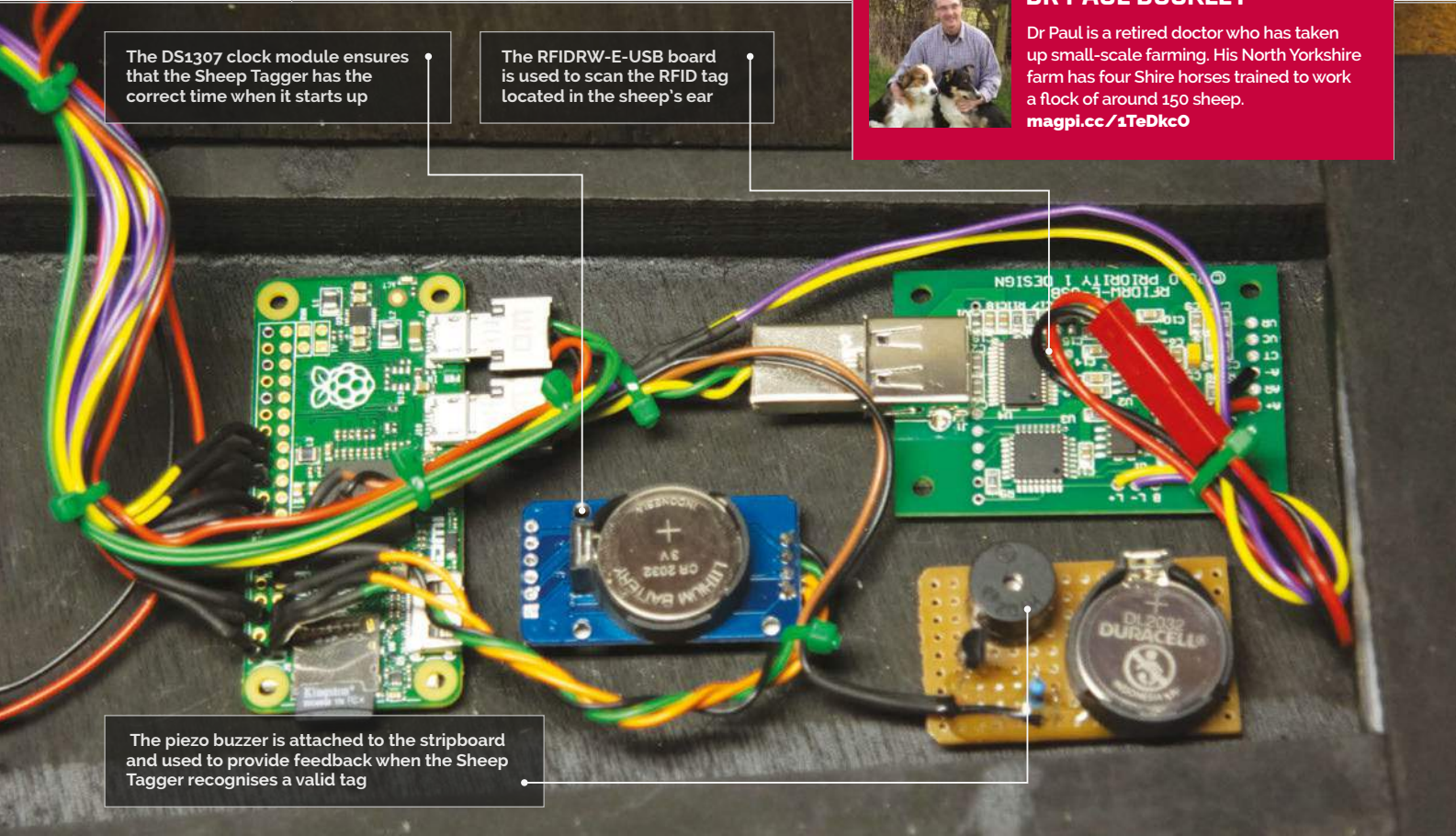

The DS1307 clock module ensures that the Sheep Tagger has the correct time when it starts up

The RFIDRW-E-USB board is used to scan the RFID tag located in the sheep's ear

The piezo buzzer is attached to the stripboard and used to provide feedback when the Sheep Tagger recognises a valid tag

**Quick Facts**

- › The enclosure was constructed from 6mm plywood and scrap timber
- › The total cost was around £60
- › The EU has introduced compulsory tagging for all sheep
- › Seventy of Dr Paul's sheep are a rare endangered breed called Soay
- › He uses four Shire horses to herd his sheep

# EIDSHEPHERD: SHEEP TAGGER

The Raspberry Pi might have been to space, but it's also proving its worth back on Earth, where in a muddy field an RFID hacked Pi is being used to tag sheep

**W**e see all kinds of cool gizmos built with the Raspberry Pi, but what really thrills us is to see our favourite computer being used to create practical projects that are useful in the real world. You don't get more real than sheep herding in North Yorkshire.

A few years ago, Dr Paul Buckley swapped intensive care for small-scale farming in Scarborough. He now has a flock of around 150 sheep.

Like all farmers, he keeps an eye on his sheep, but from last year it has been compulsory for farmers

to tag sheep with eID (electronic identification) chips. "All sheep in the UK have to have ear tags," Paul tells us, "one of which is yellow and contains a transducer holding the details of the animal."

"It's similar to the microchip identification that's common in dogs and cats," he explains.

The specification for the sheep tags are tightly controlled, and the reader has to operate at 134kHz. "Sadly, this doesn't allow the extremely cheap and easily available dog and cat chip readers to work, because they operate at a different frequency,"

says Paul. "The commercially available readers aren't cheap [£700 - £5,500], and this is prohibitively expensive."

The breakthrough arrived when Paul investigated commercial RFID readers. "I came across a supplier in Australia [[priority1design.com.au](http://priority1design.com.au)] who makes an RFID reader card for the princely sum of about £25," says Paul. "Primarily designed to be used with a laptop PC, the card has a serial data output through a USB connector and in that mode works exceptionally well. I decided that a fully portable reader that could be





The sheep have a small electronic tag fitted behind the ear that needs frequent scanning

“ The biggest issue was getting the device to emit an audible beep on successful read of the tag ”

easily carried and available for tag reading in the field would be very useful. The project was born.”

The Sheep Tagger is officially called the eIDShepherd – an eID ear tag reader for sheep. “My wife calls it the ‘cricket bat’,” laughs Paul. The heart of the Raspberry Pi is a RFIDRW-E-USB module, Adafruit 16×2 LCD display, a DS1307 clock module, and a piezo buzzer.

“I found, to my surprise and delight, that numbers appeared on the screen when I wafted an old sheep tag over the aerial of the reader module,” recalls Paul. “My wife failed to see why I was excited. I persevered and learnt how to manipulate the data string to produce CSV-compatible output, and then how to create and append it to a text file on the SD card.”

There were some challenges in turning the equipment into a fully working sheep tagger. “I discovered I needed a clock when, for the first time, I ran the Raspberry Pi off batteries and disconnected from the internet,” says Paul. “The biggest issue

was getting the device to emit an audible beep on successful read of the tag.” The workaround was buzzer hardware attached to a GPIO pin of the Pi Zero. This is momentarily set high when a data string detects the serial input.

The total cost for the final project was less than £60, much less than a commercial device. “We collect the sheep in a pen and put the tip of the Sheep Reader close to the yellow tag in the sheep’s ear. A bright blue LED on the front of the device blinks momentarily and an audible beep confirms the data acquisition. When I get home, the data is downloaded from the SD card as a text file.

“We’ve had no problems in the field,” continues Paul. “We’ve been using it alongside a laptop to ensure that there are no bad reads or missing data, but all the reads have been correct and the two systems have correlated perfectly. I am now confident to use the Sheep Reader as a standalone device.”

## EIDSHEPHERD

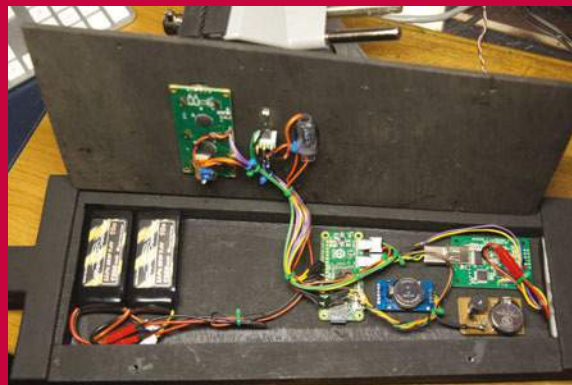

### >STEP-01

#### The cricket bat

The components are housed inside a wooden box, with two batteries used to power the Raspberry Pi and LED display. The RFID scanner is fitted at the bottom of the ‘cricket bat’.



### >STEP-02

#### Ready to tag

The LCD display provides information on the sheep being tagged. A piezo buzzer inside the bat provides feedback when a tag has been successful.



### >STEP-03

#### Tag... you're it

The Sheep Tagger in action. It's held next to the yellow tag attached to the sheep's ear. The information about that sheep is saved to a file on the device, and is examined later.





Photo: Krisztián Hofstädter

Listen to the poetry and music that make up Lichen Beacons

Experience the installation your own way, at your own pace

Search the room for more beacons to complete the story



LICHEN BEACON TEAM

The team is made up of Barry Byford, an electronic design automation specialist; Tom Hall, a music technology lecturer at Anglia Ruskin University; and Drew Milne, a poetry lecturer at the University of Cambridge. [ludions.com/projects/lichens](http://ludions.com/projects/lichens)

# LICHEN BEACONS

An interactive sound art installation which shows that science and engineering aren't the only applications for the Raspberry Pi

Quick Facts

- ▶ The project took about six months to complete
- ▶ At the time of writing, it's only been shown in two places
- ▶ While the beacons aren't Pi-powered, it could be done easily
- ▶ The music was created in SuperCollider, which is also used by Sonic Pi
- ▶ More than one work might be hosted on the platform in the future

**L**ichens, apparently, are dual organisms. Fungi and algae living together mutually, they're a good indication of air pollution and the subject of the fascinating Lichen Beacons project. This is a digital sound art

installation, involving someone walking around a large room with a portable Raspberry Pi (Pi-in-a-box) and uncovering Bluetooth beacons that activate different responses. The portable Pi comes with a screen and headphones,

and the Bluetooth responses to the Eddystone Bluetooth beacons come in the form of music, pictures, and poems.

"The idea with this platform is to make it possible to slow down and take in a digital environment, at a very different pace from the usual hectic screen-hopping and social media hot-desking that seems to define most digital environments," says the team that created the installation. Tom Hall made the music, Drew Milne wrote and read the poetry, and Barry Byford brought it all together with code.

"One of the great things about the Pi-in-a-box we created was that people needed no technical skills to use it," Barry explains. "We had a very wide range of



The 'lichen beacon' is a Bluetooth beacon; the Pi looks for its signal to trigger the poetry, music, and images.





The humble Pi-in-a-box seems like a very simple affair, but it does exactly what needs to be done

Photo: Krisztián Hofstädter

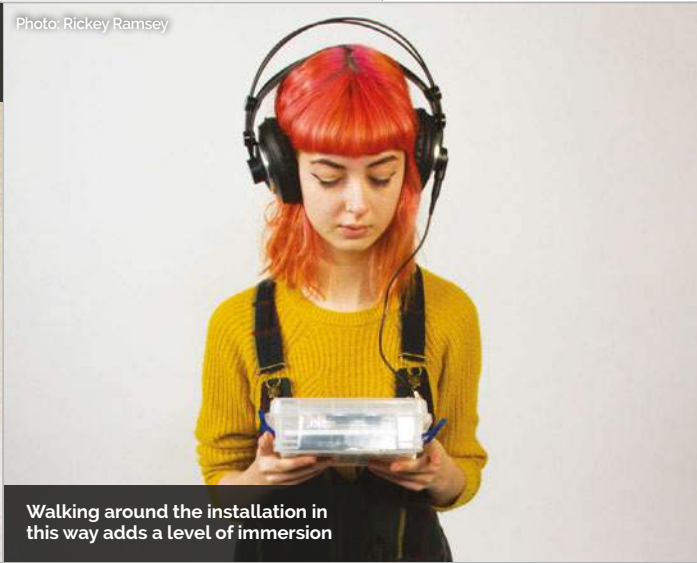

Photo: Rickey Ramsey

Walking around the installation in this way adds a level of immersion

people, including some that were self-declared technophobes, and because all they had to do was walk and explore the location looking for 'Lichen Beacons', there were no technology usage issues with the equipment. This was a very pleasing result and made the event much more inclusive."

"From my perspective, there's a special affinity between lichens, digital photography, and small screens," Drew says. "The challenge is to find a new grammar of thinking and writing that can echo the world-making symbiosis of lichen life. Our installation offers the perfect platform for

thinking about the poetics of digital environments, and how such environments relate to the world's fragile ecology... There's politics in the poetics, too: a way of thinking about how sound art can respond to the sites in which it is installed, while also opening up the larger questions of our environmental crisis. Our installation is a model for using technology in ways that are both home-made and also at the sharp end of what contemporary technology makes possible."

The sound design is binaural, with music wrapping around the sequential poems to create an

immersive experience. Part of the future plans to improve the installation involve this sound, according to Tom: "Just as the audience can experience the 18 parts of the installation in any order, I'd like to create a musical environment that responded differently to the order in which people visited the beacons."

The installation should be turning up in more places around the UK and Europe, so keep an eye out for information on where you might be able to experience it; the full event schedule can be found on the Ludions website: [ludions.com/events](http://ludions.com/events).

## SEARCH FOR BEACONS

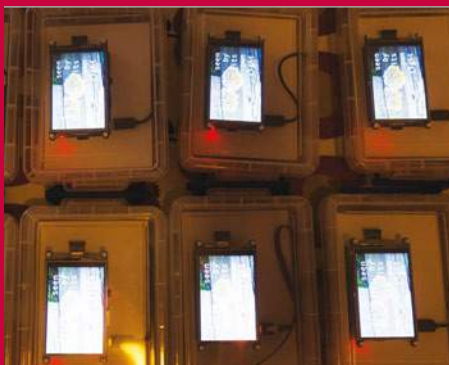

### >STEP-01 Get your gear

The Pi-in-a-box is a container that has a battery, screen, and headphones attached. All you need to do is pick it up, put it on, and carry it around.

### >STEP-02 Find the beacons

Bluetooth beacons are placed around the room, their signal strength activating different parts of the installation. You and the beacons dictate the pace.

### >STEP-03 Learn

Listen to the music, hear the poem, and take in the information. It's not just designed to look pretty: it's also trying to impart a message.

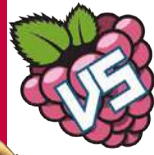

**RICHARD SAVILLE**

A business analyst who writes about his Pi projects on the blog Average Man vs Pi. [averagemanvsraspberrypi.com](http://averagemanvsraspberrypi.com)

BURT uses a Pololu motor board, which is also quite small and therefore suited to the project

It's powered by a Raspberry Pi Zero, which should also help give you a sense of the miniature scale

The LEDs come on when the motors are activated, leading the way for BURT

Tracks offer better grip and look pretty cool on a mini robot

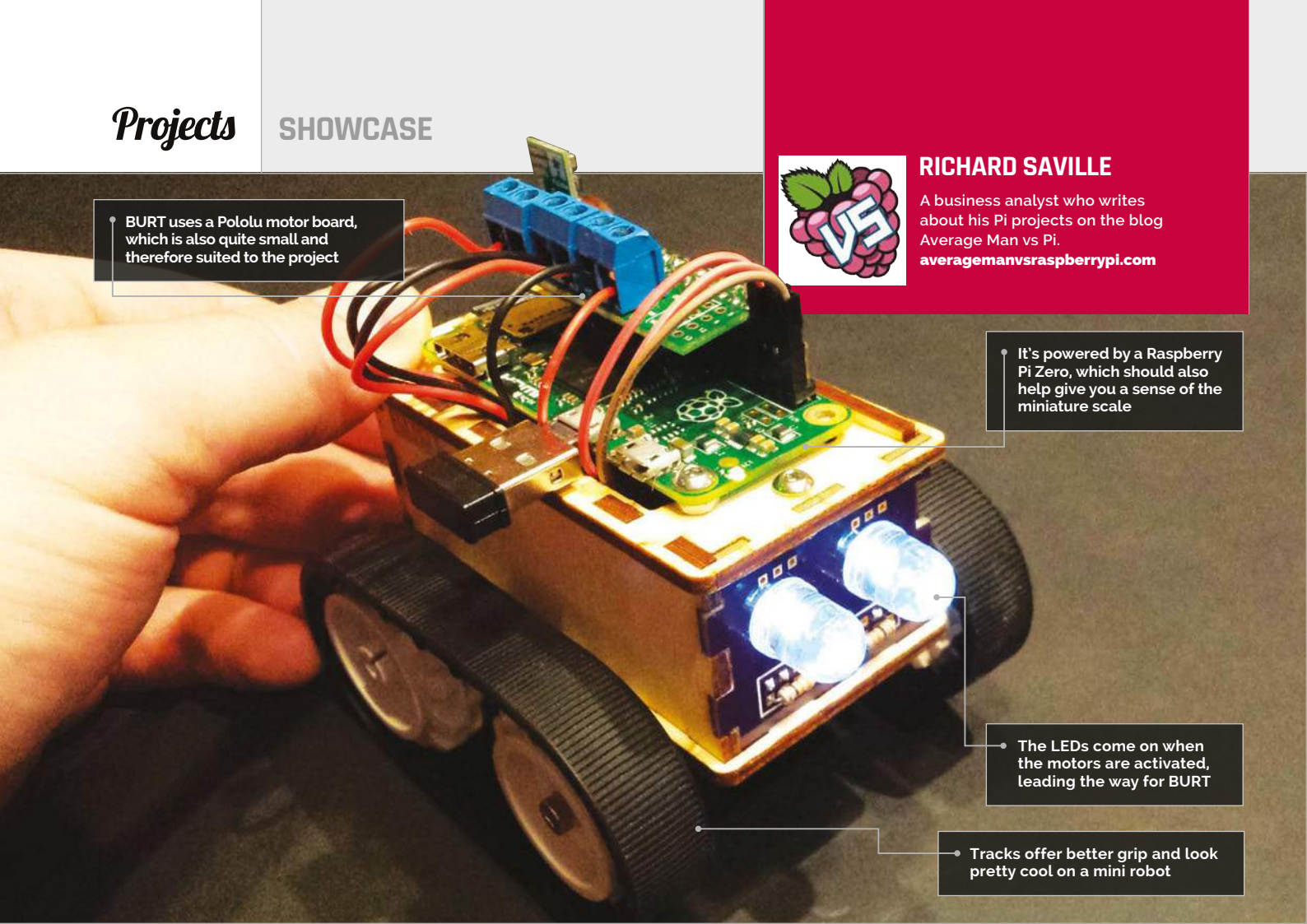

**Quick Facts**

- Work started after Pi Wars in December
- It's coded in Pygame, the module for Python
- The wood was cut at RazorLab
- A Pololu motor controller powers the Pololu motors
- The PCB face saves on wiring space

# BURT BOT

A Raspberry Pi Zero robot, **BURT** is one of the smallest and cutest robots you'll see

**R**aspberry Pi Zero robots are hardly new – in fact, in our Pi Zero launch issue (#40) we featured a fully functional Raspberry Pi Zero robot before the board was even out! The thing we like best about Pi Zero robots is that they're always quite inventive and different (such as the Matchbot), and BURT is no different.

Created by Average Man himself Richard Saville, BURT stands for Boxey Unintelligent Robot with Tracks. "I had attended Pi Wars back in December with my other robot, 'AverageBot'," Richard tells us. "When the new Pi Zero came out, I wanted to try my hand at making a mini robot

using the things I had learnt through Pi Wars."

It's a remote-controlled device, so not truly autonomous, but it's still an excellent little project. BURT comprises a custom-designed plywood chassis that can be rapidly revised and remade, a custom PCB 'face' with a couple of LEDs that react to the movement of the robot, and a series of motors. Motor drivers and remote controls finish off the robot to make it work.

"It's not complex at all in terms of features," Richard points out. "BURT has no sensors or anything clever – simply two motors and basic controls (hence the 'Unintelligent' part of the

BURT name). The complex part is putting it all together and working out where everything can go, whilst trying to maintain a small footprint. Everything is compact and fiddly, but that was always the aim."

BURT is still a work in progress, but Richard seems happy with the way it has turned out so far: "I aimed to make a small basic robot that could move around; that part works as intended, and the media centre remote control does the job well. BURT seems to be able to negotiate a range of different terrains with ease."

Some of Richard's plans to upgrade BURT should help to make it more autonomous. First



## MOVING BURT

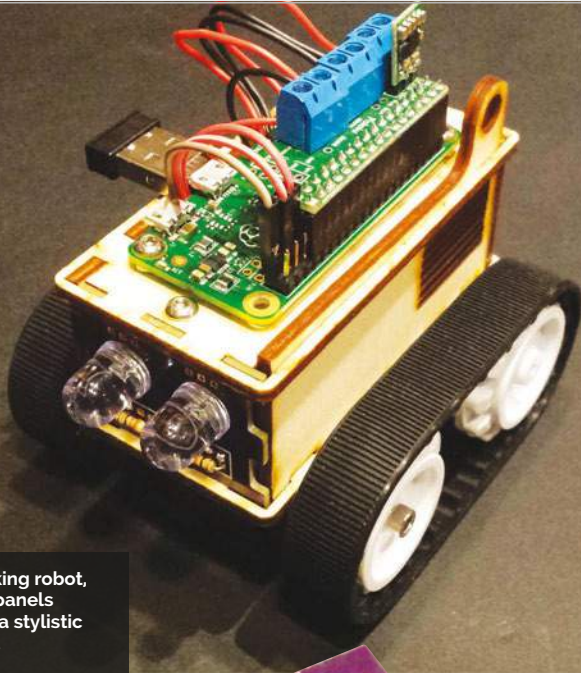

It's a great-looking robot, with the wood panels giving it an extra stylistic flair that suits it

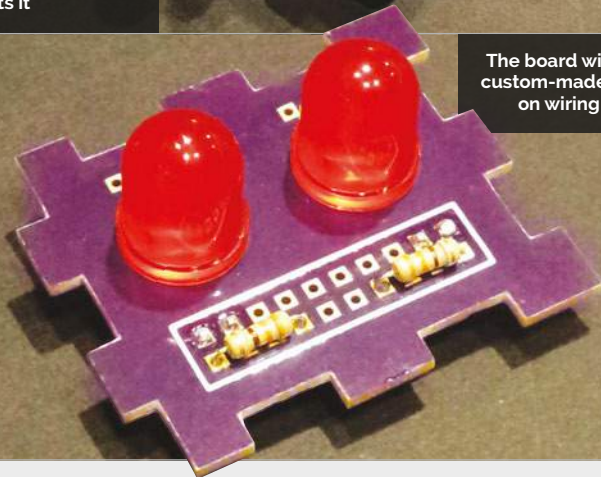

The board with the LEDs is custom-made, to cut down on wiring in the project

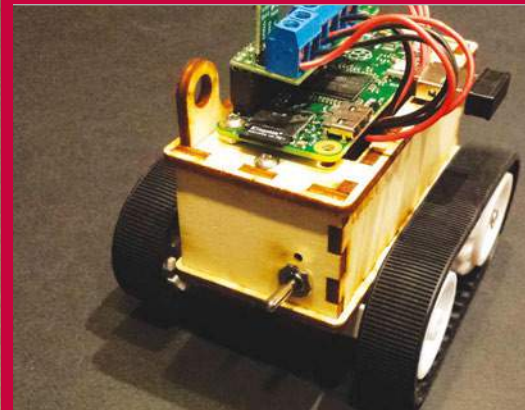

### >STEP-01

#### Turn it on!

You'll need to add some batteries and get the Pi started up. This will provide power for the motors, then you can start the script to use it.

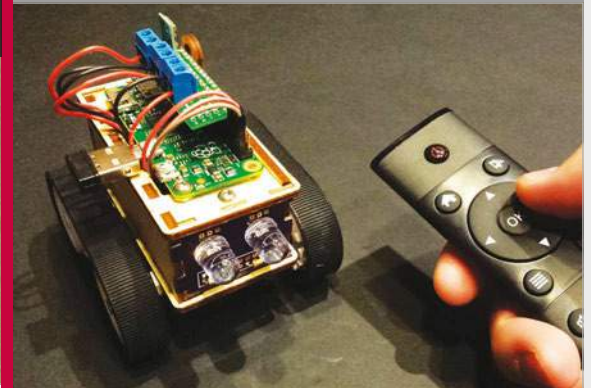

### >STEP-02

#### Controlling BURT

BURT is currently controlled with a media centre remote, which is picked up by a USB sensor. The LEDs on the front react to BURT's movement.

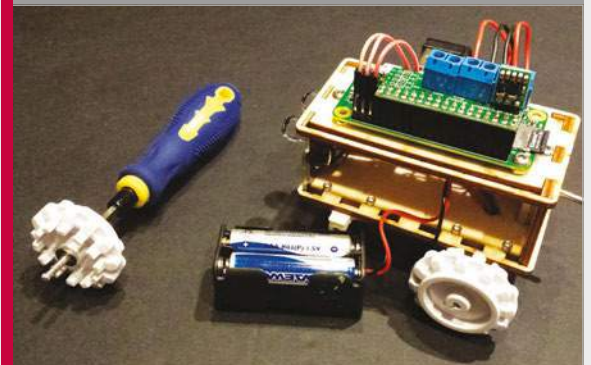

### >STEP-03

#### Recharge

Currently, BURT uses four AAA batteries to power itself, but they don't last too long, so you'll need to replace them every so often.

on the agenda is to try to add a line sensor, much like the CamJam EduKit robot. The current power source, a series of AAA batteries, doesn't last very long either, so he's considering replacing it with a rechargeable LiPo one: "LiPo batteries still scare me a bit after

they don't play live as Pink Floyd anymore. To become #1 son, I'm making him a Pi screen unit, coded with Pygame, that will let him choose a country and see all the live gig videos. I can't get him a ticket, but I can take him back in time (kind of)!"

“ I wanted to try my hand at making a mini robot using the things I had learnt through Pi Wars ”

seeing some videos of them 'going bad', but I may give it a try.”

Asides from BURT, Richard does have other Pi projects planned.

“I've got a really cool project partially completed for Father's Day,” Richard reveals. “My dad is a huge Pink Floyd fan and has never see them play, but of course

Robots and time machines with the Raspberry Pi, then. Richard does have a major tip for anyone wanting to give a robot like his a go, though: “If anyone wants to try something similar, remember the old rule and don't make the same mistakes as I did: 'measure twice, cut once'.”



# *The* **MagPi**

## ESSENTIALS

LEARN | CODE | MAKE

AVAILABLE NOW:

- > CONQUER THE COMMAND LINE
- > EXPERIMENT WITH SENSE HAT
- > MAKE GAMES WITH PYTHON
- > CODE MUSIC WITH SONIC PI

---

*The*  
**MagPi**  
ESSENTIALS

From the makers of the  
official Raspberry Pi magazine

---



---

**OUT NOW IN PRINT**  
**ONLY £3.99**  
*from*  
**[raspberrypi.org/magpi](http://raspberrypi.org/magpi)**

---



GET THEM  
DIGITALLY:





**FRANCESCO VANNINI  
AKA GARAGE TECH**

Advocate of physical computing, digital fabrication, and tech recycling.  
[garagetech.tips](http://garagetech.tips) / [@GarageTechTweet](https://twitter.com/GarageTechTweet)

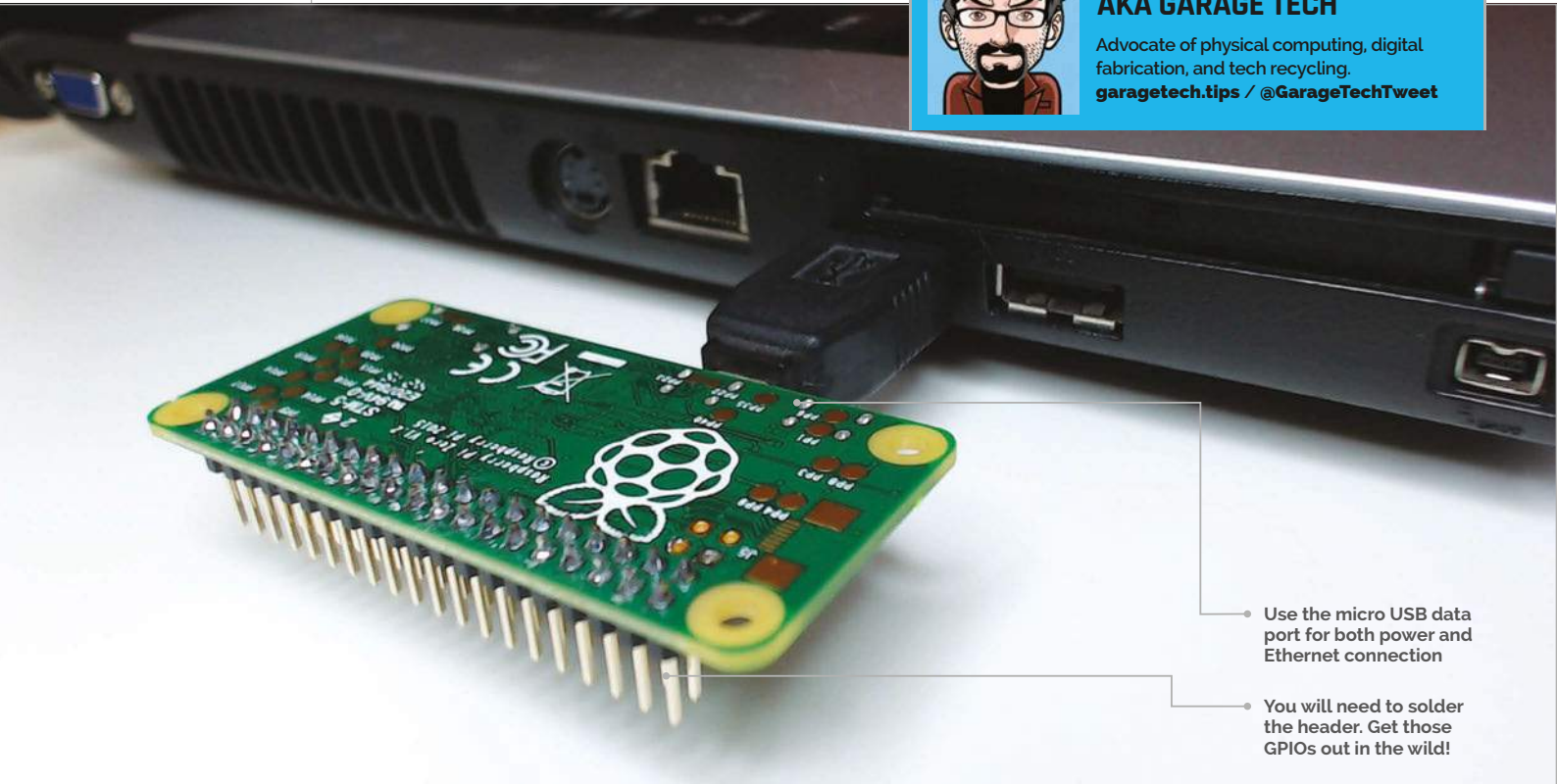

# PI ZERO SIDECAR

Turn any laptop into a fully-functional Pi-top with a Pi Zero USB gadget

## You'll Need

- ▶ Ryantech Raspberry Pi Debug Clip or similar [magpi.cc/225SiDG](http://magpi.cc/225SiDG)
- ▶ Bonjour for Windows [magpi.cc/225SmmK](http://magpi.cc/225SmmK)
- ▶ PuTTY [magpi.cc/1Mm5Npi](http://magpi.cc/1Mm5Npi)
- ▶ VNC Viewer [realvnc.com/download/viewer](http://realvnc.com/download/viewer)

**W**ould you like to transform your Pi Zero into an Ethernet USB gadget? You can then plug it into your PC as a USB stick and give it a screen, mouse, and keyboard in the most compact and inexpensive way possible.

This tutorial assumes that you'll be working from a Windows platform, but if you have a good grasp of other operating systems, it should be easy to apply this to Linux or Mac.

We're also assuming that you know how to prepare an SD card with Raspbian Jessie (full desktop), and that you know your way around PuTTY and VNC.

### Get Raspbian ready

Start by preparing your SD card. While that's processing, it's a good time to visit Adafruit's website and start downloading the new kernel we're going to use to transform our Pi Zero into an USB Ethernet gadget: [magpi.cc/1R9nuQJ](http://magpi.cc/1R9nuQJ).

Whichever way you've prepared your SD card, chances are that at this point it's still in your reader. This is a great opportunity to transfer the new kernel you've just downloaded so that we can get the other steps done directly on the Pi.

Rename the Adafruit file to **gadgetkernel.tgz** and move it to your SD card at the root level.

### Solder, serial debugger and terminal

In order to get your Pi Zero Sidecar set up, some advance preparation is needed.

Solder the GPIO header on your Pi Zero, so that you can use a USB-to-TTL serial cable to connect to it while configuring it to become an Ethernet gadget.

We have used Ryantech's Raspberry Pi Debug Clip because it offers a really clean and foolproof solution.

If you're going to use something different, be careful with the connections. You'll need to follow the diagram shown overleaf.

At this point, you're ready to fire up your Pi Zero. Connect your serial-to-TTL cable or your Pi Debug Clip, and Windows should be able to download the correct drivers for you. Be wary that some Prolific-based adapters won't work correctly and you'll need to find a workaround to install the correct driver.

Our Debug Clip was recognised as COM3. Find how yours is configured in Device Manager.

Your Pi is booting up in the meantime, and by now it should be ready for you to finally connect to it. Get onto PuTTY, choose to connect via Serial and make sure to change the baud rate to 115200.

You should be prompted for a login: the username is **pi** and the password is **raspberry**.



## Begin the mutation

As you log in, you should be able to notice the kernel version that comes as standard with 2016-03-18-raspbian-jessie. If you have missed it, just type:

```
uname -r
```

You should get 4.1.19.v7+ (or later). Since we're doing some exploring, type the following commands and save the output by copy/pasting it into a text editor, along with the kernel version from above:

```
lsmod
```

...and:

```
ls -la /boot/kernel.img
```

Good: let the mutation begin. You need to unpack and move the new kernel in order to replace the original one. Doing this will ensure that a newer version with extra modules will be used instead, allowing us to enable the USB gadget functionality. In our particular case the Ethernet Gadget has been enabled in the new kernel, so all we need to do is to provide some overlays and modules for it to work correctly.

To unpack the kernel, execute the following commands in a terminal.

```
cd ~
sudo mv /boot/gadgetkernel.tgz .
tar -xvzf gadgetkernel.tgz
```

Just to be on the safe side, we're also going to backup the original kernel. Execute the following commands from your home directory, which you won't have to move away from throughout the rest of the steps.

```
sudo mv /boot/kernel.img /boot/kernel.img.org
```

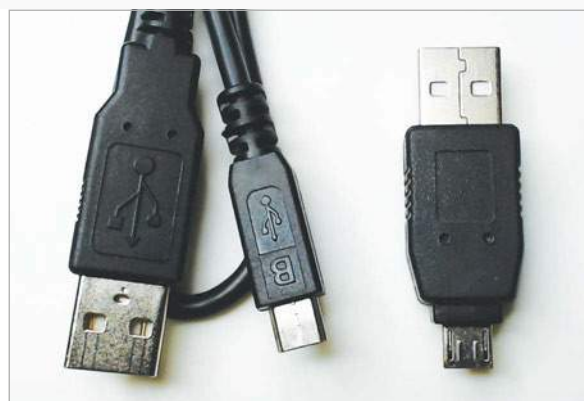

**Above** Either of these will connect your Pi to your laptop. The one on the right will make it look cooler, though!

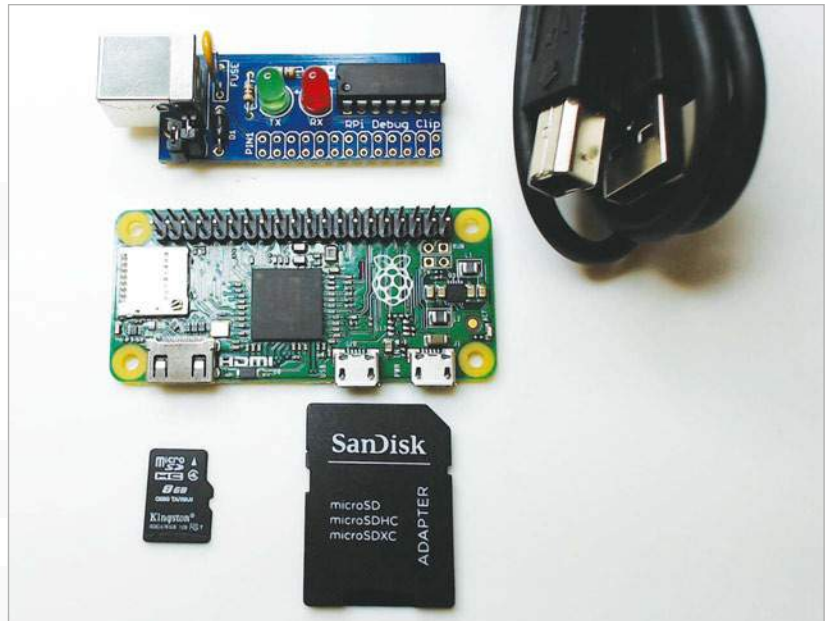

Now replace the old kernel with the new one:

```
sudo mv tmp/boot/kernel.img /boot/
```

Ignore the following message, as it won't affect the outcome of what you're doing:

```
mv: failed to preserve ownership for '/boot/kernel.img': Operation not permitted
```

You'll get this type of message several times in the next two steps.

We now need to install both the overlays and modules...

```
sudo mv tmp/boot/overlays/* /boot/overlays/
sudo mv tmp/boot/*dtb /boot
sudo cp -R tmp/boot/modules/lib/* /lib
```

The moving and copying is finished. Before we reboot, we just need to change a few configuration files.

The first file to edit is `/etc/modules`, in which we're going to tell the kernel to load the `g_ether` module.

```
sudo nano /etc/modules
```

...and add `g_ether` at the bottom of the file. Ours looks like this:

```
# /etc/modules: kernel modules to load at
boot time.
...
i2c-dev
g_ether
```

The other file that we need to change is `/etc/network/interfaces`:

**Above** This is what you'll need to set up your Pi Zero Sidecar

### CHECK YOUR RNDIS CONNECTION STATUS

From Network and Sharing Center, select 'Change adapter settings'. Right-click on the RNDIS interface (Local Area Connection 2) and select Status. We are running at 425.9Mbps!

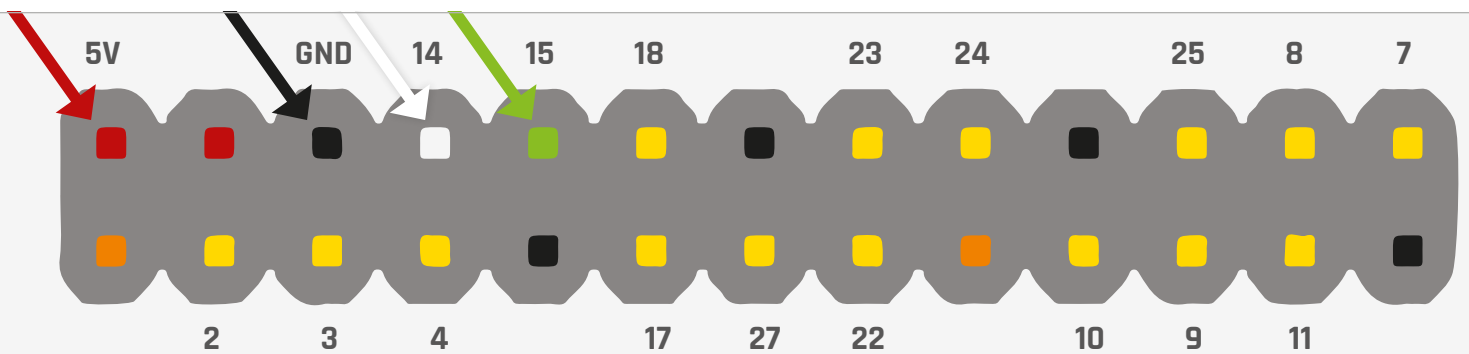

```
sudo nano /etc/network/interfaces
```

Here, you need to add the following lines:

```
# interfaces(5) file used by ifup(8) and
ifdown(8)
```

```
...
```

```
auto lo usb0
iface lo inet loopback
```

```
...
```

```
allow-hotplug usb0
iface usb0 inet manual
```

This will allow the Pi Zero to bring up the usb0 network interface and automatically configure an IP address.

All is ready for the long-awaited reboot, so let's do just that!

```
sudo reboot
```

### WHAT ARE 169.254.X.Y ADDRESSES?

Automatic Private IP Addressing is Microsoft's interpretation of link-local address. It's a way of auto-assigning IP addresses to hosts within a network segment without the need for a DHCP (a role that is typically the job of your home router or NAS). A Class B of IP addresses has been reserved just for this purpose:

169.254.0.0/16 or 169.254.0.1 through to 169.254.255.254, with 169.254.0.0 being the subnet and 169.254.255.255 being the broadcast address. The network mask is 255.255.0.0.

In the absence of a DHCP, a Windows system (or any other OS supporting link-local address) will be configured as 169.254.x.y – this is the case for the Pi, too, with Raspbian Wheezy or Jessie.

Once the Pi is off, remove the serial-to-TTL cable or the Pi Debug Clip and plug the micro USB connector into the USB data port of the Pi Zero – the other side obviously goes into your laptop or PC.

After a while, you should hear the familiar sound of a USB peripheral being detected by your Windows OS.

A new RNDIS driver should be automatically downloaded and installed. Check in Device Manager that all is good. You should see the RNDIS network card amongst your others.

If this is the case, then you are truly very close to being able to SSH to your Pi Zero via USB!

### Sorting out the networking

If you open up your Networking and Sharing Center, you should notice that the new Local Area Network created by the RNDIS driver is marked as public.

This might create some problems for the next few steps, as local firewalls will look at traffic coming from a public network as something bad – as they should. For our purposes, though, this will make things difficult and, until the setup is finished, we'd recommend you disable the local firewall and re-enable it only at the end. Once we know how things should look, we'll be able to re-enable the firewall and configure it to allow for the necessary traffic only.

At this point, we want to be able to refer to the Pi as **raspberrypi.local** instead of an IP address, automatically configure the networking for the Pi, and be able to remotely connect to it via VNC.

The magic that allows you to resolve **raspberrypi.local** is called mDNS and it is natively supported in Raspbian, in Linux in general, in Mac OS X, but not in Windows. Worry not, though, because Apple is generous enough to provide a package to allow Windows to say 'Bonjour' to the Pi.

Simply download and install it from Apple's website: [magpi.cc/225SmmK](http://magpi.cc/225SmmK).

Once Bonjour is running, you should be able to resolve **raspberrypi.local**. To test it, simply open a command line session by typing **cmd.exe** in 'Search programs and files' on the Start menu. Once the window opens up, simply type:

```
ping raspberrypi.local
```



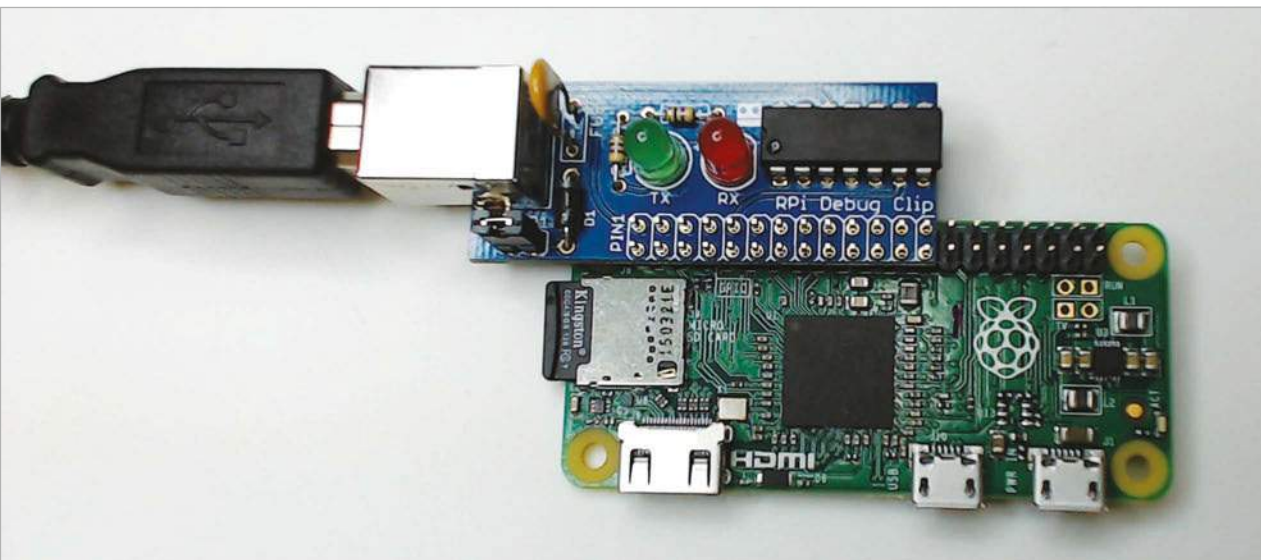

**Left** Make sure that JP1 in the Debug Clip is closed, as this will allow you to power the Pi Zero directly from the Debug Clip

...and you should get a few replies from your Pi. Your Pi and Windows can communicate at the IP level because they both support link-local address, but this won't be enough for the Pi to connect to the internet.

To do so, we need to enable Internet Connection Sharing (ICS) on Windows, so that the Pi not only gets an IP address, but will also be able to use the Windows box as a gateway to the internet.

Enabling ICS is very easy. Under Network and Sharing Center on your Windows PC, select 'Change adapter settings'.

We needed to share our Wireless Network Connection; in most cases, this will be the same for you too. Right-click on the Wireless Network Connection, go to Properties, move to the Sharing Tab, and select at least the checkbox on top. If you have more than two cards, you'll also need to choose the Connection which you are going to share to. In our case, it was Local Area Connection 2 that was created by the RNDIS driver and to which the Pi Zero is connected.

This will configure the Local Area Connection 2 with the 192.168.137.1 IP address and enable the interface to work as a DHCP, thereby issuing an address like 192.168.137.x to the Pi.

Click OK on the window and try to ping **raspberrypi.local**, as we did earlier. Your Pi should now reply with its new 192.168.137.x IP address.

## See the desktop

The last piece of the puzzle is to enable VNC. With PuTTY, we will now connect to the Pi Zero via SSH. Open a PuTTY connection to the Pi by using:

```
raspberrypi.local
```

As you log in, get back to the output of the commands we saved earlier on and compare it with the new results when issuing the same command as

before. You should notice the more updated kernel and the **g\_ether** module being loaded, as we expected.

From the command prompt, execute the following to install TightVNC Server:

```
sudo apt-get install tightvncserver
```

If all the steps above have been performed correctly, the package should be downloaded from the internet using your laptop's wireless connection. Cool!

Next, enable the VNC Server:

```
vncserver -geometry 1280x800
```

1200×800 is just an example resolution – use whichever you want for your laptop screen, up to the full resolution. Note that running the command above will create a session on screen :1.

Time to run VNC Viewer from our Windows box and enjoy the fruits of our hard work: connect to your Pi Zero Sidecar by entering **raspberrypi.local:1** in VNC Viewer.

The setup and configuration of this can be hugely improved and automated, and we're sure it will become a lot easier in the future. Running the VNC server automatically on the Pi can, for example, already be done – you can find resources about this directly from the **raspberrypi.org** website. Also, it would be nice if the Pi would gracefully shut down as the laptop initiates its own shutdown. For the time being, just remember to shut down your Pi before shutting down your laptop. Simply run:

```
sudo reboot
```

...and wait a few seconds.

That's it! We hope you enjoyed setting up your Pi Zero Sidecar. Use it to make your Pi more portable, and maybe revive a decrepit laptop you have hidden somewhere which can now have a second life.

## HOW DO LOCAL NAMES WORK?

mDNS is for DNS what link-local address is for IP, and it allows for DNS names to be set up 'democratically' amongst computers in the same network.



**ROB ZWETSLOOT**

Tinkerer, sometime maker, other-times cosplayer, and all the time features editor of *The MagPi*.  
magpi.cc

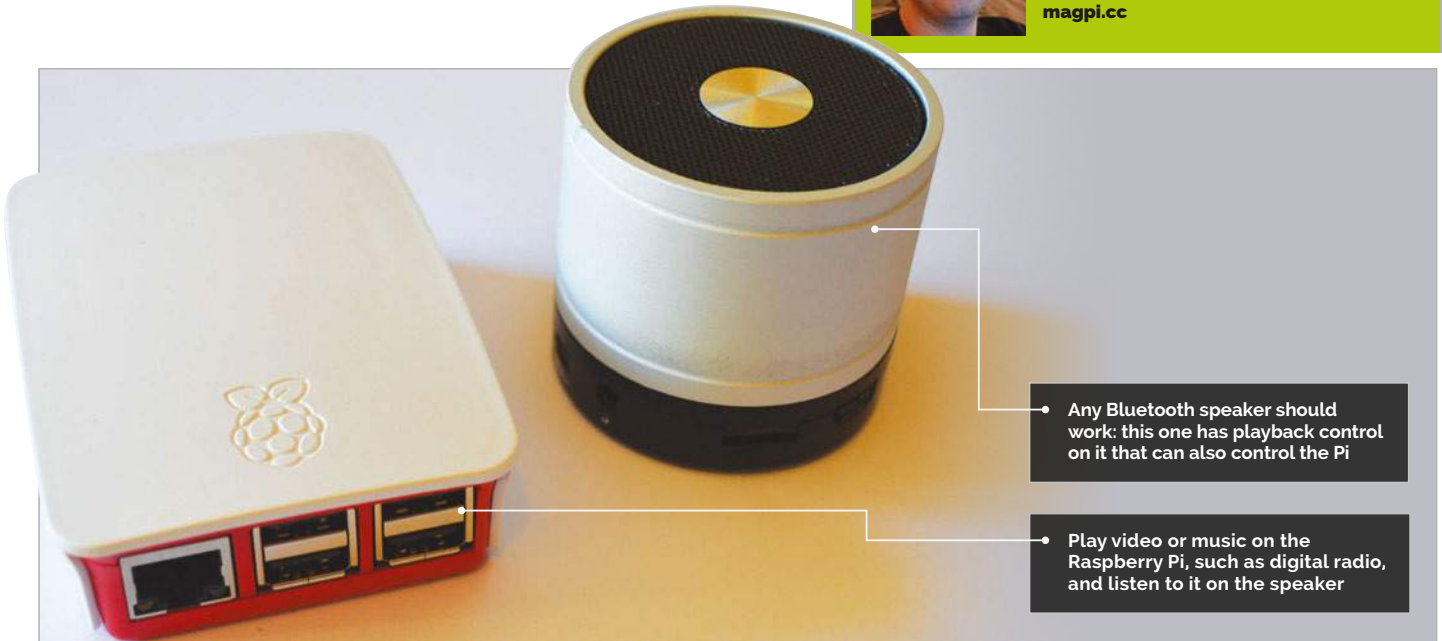

Any Bluetooth speaker should work: this one has playback control on it that can also control the Pi

Play video or music on the Raspberry Pi, such as digital radio, and listen to it on the speaker

# PLAY AUDIO ON A BLUETOOTH SPEAKER WITH RASPBERRY PI 3

## You'll Need

- > Raspberry Pi 3
- > Blueman [magpi.cc/1UHNQBH](http://magpi.cc/1UHNQBH)
- > Bluetooth speaker

Make use of the Raspberry Pi 3's brand new Bluetooth capabilities to play audio and/or music over a wireless speaker, without using a dongle!

**A**n oft-requested feature, Bluetooth support on the Raspberry Pi 3 board – along with its wireless LAN capability – has been pretty well received in the Pi and maker communities at large. How can you use it, though?

In this tutorial, we'll cover the basics of how to get your Bluetooth up and running on the Pi 3, and how to connect to a Bluetooth speaker so you can play all your smooth Sonic Pi tunes that you've been learning from Sam Aaron's tutorials.

## >STEP-01 Set up the Raspberry Pi

While Bluetooth is on the Raspberry Pi 3, you need to install a few bits of software to make sure it works properly. It's best to start by making sure your version of Raspbian Jessie (this won't work on Wheezy) is up to date. Open the terminal and begin with:

```
sudo apt-get update
sudo apt-get dist-upgrade
```

Follow this up by installing the Raspberry Pi Bluetooth software and the excellent Blueman Bluetooth manager:

```
sudo apt-get install pi-bluetooth blueman
```

You may need to reboot after this, but you'll probably be fine to carry on to the next step.

## >STEP-02 Set up your Bluetooth speaker

Make sure your Bluetooth speaker is all charged up and ready to go, then switch it on. Ours has a satisfying beep once you do so. If there's a syncing button or sequence for it to start searching to pair with devices, press it/do it and head back to the Raspberry Pi. If you want to check whether the speaker is actually looking, you could always find out if a mobile phone or tablet is able to see it. Don't pair with it, though, as that might cause problems in the future.

## MORE BLUETOOTH

This way of connecting via Blueman will work with almost any Bluetooth device.



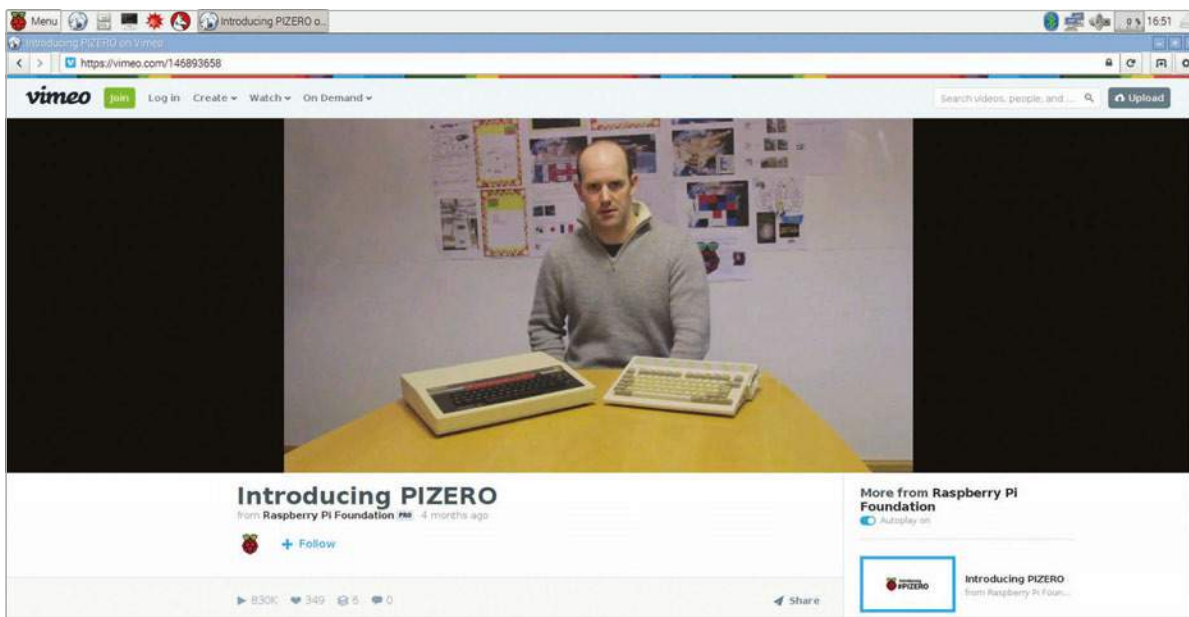

Left Listen to audio from videos or install a media player like VLC to stream music from your Pi to the speaker

>STEP-03  
Connect the speaker up

Open up Blueman by going to the program menu, Preferences, and Bluetooth Manager. As long as the speaker is still trying to sync, clicking Search should make it show up in the interface. Right-click on it, then hit Pair. It should connect to the device, shown by a few information bars on the connection strength – if it then suddenly disconnects straight afterwards, you may need to right-click on it again and hit Connect. Test it out by playing a video on YouTube; it may work straight away like this!

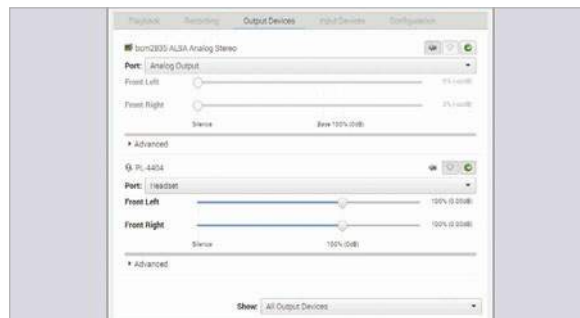

Left PulseAudio offers better control of the audio output to the Bluetooth device than the defaults

you can switch to the Bluetooth speaker. You'll more than likely need to reboot the Raspberry Pi – do that now!

>STEP-04  
More setup

Depending on how your Pi is set up, the Bluetooth audio might not work at step 3. If this is the case, it's best to install some extra software to try to get it working. Open up the terminal again and install PulseAudio and its Bluetooth module:

```
sudo apt-get install pulseaudio
pavucontrol pulseaudio-module-bluetooth
```

If you open the PulseAudio panel now, it may not show much information, especially whether or not

>STEP-05  
Connecting with PulseAudio

After the Raspberry Pi has booted back up, check the Volume Control option in the Sound & Video category of the program menu. On output devices, it should list bcm2835 ALSA as the default output. Go and connect or re-pair with the Bluetooth audio device and it should then be picked up as an option in the Volume Control. Try playing a YouTube video again: you may need to mute ALSA and set the Bluetooth device as a fallback, but it should start playing the audio!

>STEP-06  
Bluetooth uses

There are some quite obvious uses for Bluetooth speaker connections: not all monitors have audio out, so this solves that issue. This means videos, games, and music (especially the kind from Sonic Pi) are now available to you. You could also incorporate it into a project and create an internet radio player for yourself, activated with the touch of a button. It could be used in a scary Halloween decoration that houses multiple screams and whispers. There's a lot you can do with this new functionality!

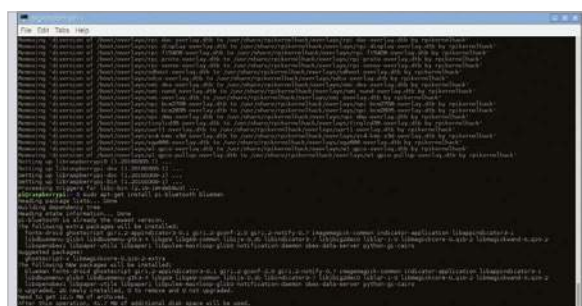

Above Install all the software you need: it's not much and you may already have some of it

**PAIRING PROBLEMS**

If you're trying to pair with a device that is paired to a computer or phone, turn the PC or phone's Bluetooth off and try again.

# π))) Sonic Pi PART 9



SAM AARON

Sam is the creator of Sonic Pi. By day he's a research associate at the University of Cambridge Computer Laboratory; by night he writes code for people to dance to. [sonic-pi.net](http://sonic-pi.net)



# TRACKING THE BEAT

## You'll Need

- ▶ Raspberry Pi running Raspbian
- ▶ Sonic Pi v2.7+
- ▶ Speakers or headphones with a 3.5mm jack
- ▶ Update Sonic Pi:  
`sudo apt-get update && sudo apt-get install sonic-pi`

In this month's deep dive into coding music with Sonic Pi, its creator **Sam Aaron** looks at the unique tick system...

Last month in this series, we took a deep technical dive into the randomisation system underpinning Sonic Pi. We explored how we can use it to deterministically add new levels of dynamic control over our code. This month, we're going to continue our technical dive and turn our attention to Sonic Pi's unique tick system. By the end of this article, you'll be ticking your way through rhythms and riffs on your way to being a live-coding DJ.

## Beat counting

When making music, we often want to do a different thing depending on which beat it is. Sonic Pi has a special beat counting system called **tick** to give you precise control over when a beat actually occurs, and even supports multiple beats with their own tempos.

Let's have a play – to advance the beat, we just need to call **tick**. Open up a fresh buffer, type in the following, and press Run:

```
puts tick #=> 0
```

This returns the current beat: **0**. Note that even if you press Run a few times, it will always return **0**. This is because each run starts a fresh beat, counting from 0. However, while the run is still active, we can advance the beat as many times as we want:

```
puts tick #=> 0
puts tick #=> 1
puts tick #=> 2
```

Whenever you see `#=>` at the end of a line of code, it's just a handy note to say that line will log the text on the right-hand side. For example, `puts foo #=> 0` means the code `puts foo` prints **0** to the log at that point in the program.

## Checking the beat

We've seen that **tick** does two things. It increments (adds one) and returns the current beat. Sometimes we just want to look at the current beat without having to increment it, which we can do via **look**:

```
puts tick #=> 0
puts tick #=> 1
puts look #=> 1
puts look #=> 1
```

In this code, we tick the beat up twice and then call **look** twice. We'll see the following values in the log: **0, 1, 1, 1**. The first two **ticks** returned **0**, then **1** as expected, then the two **looks** just returned the last beat value twice, which was **1**.

## Rings

So now we can advance the beat with **tick** and check the beat with **look**. What next? We need something to tick over. Sonic Pi uses rings for representing riffs, melodies and rhythms, and the tick system has been specifically designed to work very closely with them. In fact, rings have their own dot version of **tick** which does two things. Firstly, it acts like a regular tick and increments the beat. Secondly, it looks up the ring value, using the beat as the index. Let's take a look:

```
puts (ring :a, :b, :c).tick #=> :a
```

**.tick** is a special dot version of **tick** which will return the first value of the ring **:a**. We can grab each of the values in the ring by calling **.tick** multiple times:

```
puts (ring :a, :b, :c).tick #=> :a
puts (ring :a, :b, :c).tick #=> :b
puts (ring :a, :b, :c).tick #=> :c
puts (ring :a, :b, :c).tick #=> :a
puts look                    #=> 3
```



Take a look at the log and you'll see **:a**, **:b**, **:c**, and then **:a** again. Notice that **look** returns **3**. Calls to **.tick** act just like they are regular calls to **tick** – they increment the local beat.

## A live loop arpeggiator

The real power comes when you mix **tick** with rings and live loops. When combined, we have all the tools we need to both build and understand a simple arpeggiator. We need just four things:

1. A ring containing the notes we want to loop over.
2. A means of incrementing and obtaining the beat.
3. The ability to play a note based on the current beat.
4. A loop structure to keep the arpeggiator repeating.

These concepts can all be found in the following code:

```
notes = (ring 57, 62, 55, 59, 64)

live_loop :arp do
  use_synth :dpulse
  play notes.tick, release: 0.2
  sleep 0.125
end
```

Let's look at each of these lines. First, we define our ring of notes which we'll continually play. We then create a **live\_loop** called **:arp** which loops round for us. Each time round the **live\_loop**, we set our synth to **:dpulse** and then play the next note in our ring using **.tick**. Remember that this will increment our beat counter and use the latest beat value as an index into our notes ring. Finally, we wait for an eighth of a beat before looping round again.

## Multiple simultaneous beats

A really important thing to know is that ticks are local to the **live\_loop**. This means that each **live\_loop** has its own independent beat counter. This is much more powerful than having a global metronome and beat. Let's take a look at this in action:

```
notes = (ring 57, 62, 55, 59, 64)

with_fx :reverb do
  live_loop :arp do
    use_synth :dpulse
    play notes.tick + 12, release: 0.1
    sleep 0.125
  end
end

live_loop :arp2 do
  use_synth :dsaw
  play notes.tick - 12, release: 0.2
  sleep 0.75
end
```

## Clashing beats

A big cause of confusion with Sonic Pi's tick system is when people want to tick over multiple rings in the same **live\_loop**:

```
use_bpm 300
use_synth :blade
live_loop :foo do
  play (ring :e1, :e2, :e3).tick
  play (scale :e3, :minor_pentatonic).tick
  sleep 1
end
```

Even though each **live\_loop** has its own independent beat counter, we're calling **.tick** twice within the same **live\_loop**. This means that the beat will be incremented twice every time round. This can produce some interesting polyrhythms, but is often not what you want. There are two solutions to this problem. One option is to manually call **tick** at the start of the **live\_loop** and then use **.look** to look up the current beat in each ring. The second solution is to pass a unique name to each call to **.tick**, such as **.tick(:foo)**. Sonic Pi will then create and track a separate beat counter for each named tick you use. That way, you can work with as many beats as you need! See the section on named ticks in 9.4 of the built-in tutorial for more information.

## Bringing it all together

Let's bring all this knowledge of ticks, rings and live loops together for a final fun example. As usual, don't treat this as a finished piece. Start changing things and play around with it, and see what you can turn it into. See you next time...

```
use_bpm 240
notes = (scale :e3, :minor_pentatonic).shuffle

live_loop :foo do
  use_synth :blade
  with_fx :reverb, reverb: 8, room: 1 do
    tick
    co = (line 70, 130, steps: 32).tick(:cutoff)
    play (octs :e3, 3).look, cutoff: co, amp: 2
    play notes.look, amp: 4
    sleep 1
  end
end

live_loop :bar do
  tick
  sample :bd_ada if (spread 1, 4).look
  use_synth :tb303
  co = (line 70, 130, steps: 16).look
  r = (line 0.1, 0.5, steps: 64).mirror.look
  play notes.look, release: r, cutoff: co
  sleep 0.5
end
```



**RICHARD HAYLER**

Richard is a mentor at CoderDojo Ham. His school Code Club was one of the winning teams in the Primary Astro Pi competition who now have their code on the ISS.  
[richardhayler.blogspot.co.uk](http://richardhayler.blogspot.co.uk)  
[@rdhayler](https://twitter.com/rdhayler) / [coderdojoham.org](http://coderdojoham.org)



- Use sticky tape to make a seal around the pointy end of your pump
- The LED matrix is a great way of displaying your results
- Use a power bank to create a more portable sensor for mobile investigations

*You'll Need*

- > A Sense HAT [magpi.cc/1TGGUt5](http://magpi.cc/1TGGUt5)
- > A bicycle pump with a needle ball adapter
- > A power bank
- > A Ziploc sandwich bag
- > Sticky tape

# SENSE HAT SCIENCE: PART 02

# PRESSURE

The late great David Bowie was under it, while Maximo Park like to apply some. But what is pressure?

**A**dding a Sense HAT to your Raspberry Pi can transform it from an amazingly small computer into a powerful scientific measuring device. In the first Sense HAT Science article last issue, we looked at the LED matrix and the properties of light and colour. The Sense HAT also has an array of useful sensors that can measure various environmental conditions, and we're going to take a look at a couple of these over the next few months. We'll kick things off with some atmospheric pressure fun, using the Pi as a digital barometer.

Attach the Sense HAT to your Pi and power it up. Open IDLE 3 and, as we always do when using the Sense HAT, import the library and connect to the board:

```
from sense_hat import SenseHat
sh = SenseHat()
```

Taking a pressure reading is simple and can be done with a single line:

```
sh.get_pressure()
```

This should produce a number like 1016.87158203125 (if you just get back a 0 the first time, run the command again). The number represents the

atmospheric pressure (sometimes also called barometric pressure) at your location, in millibars. This is defined as the pressure exerted by the weight of air in the Earth's atmosphere above the measurement point.

### Pressure variances

You've probably heard pressure mentioned during the weather forecast, and the barometer was one of the earliest tools used to predict the weather. People noticed that the atmospheric pressure tends to be lower during stormy, unsettled periods and higher when conditions are fine. Most countries have a network of online local weather stations, and you can compare the values for atmospheric pressure reported by your Sense HAT with those of nearby stations; in the UK, go to [metoffice.gov.uk](http://metoffice.gov.uk). These measurements can then be collated for surface weather analysis to help find surface troughs, high pressure systems, and frontal boundaries.

Unless you're in a sealed environment like the International Space Station, you'll find that pressure varies all the time. Let's turn our Pi and Sense HAT into a mobile pressure recorder so that we can explore these local variations more easily.

Download or type up the code from the listing and then restart the Pi on battery power. Start the



# underpressure.py

```
import logging # Makes it easy to log data to file
from sense_hat import SenseHat
from datetime import datetime
from time import sleep

# Set up the logfile name based on date/time
logfile = "pressure-"+str(datetime.now()).
strftime("%Y%m%d-%H%M")+ ".csv"
# Logging settings and format for csv
logging.basicConfig(filename=logfile, level=logging.
DEBUG,
    format='%(asctime)s %(message)s',
    datefmt='%Y-%m-%d, %H:%M:%S,')

sh = SenseHat() # Initialise Sense HAT
p_old = 0 # Previous reading
b = [0,0,0] # All LEDs off
c = [255,0,0] # Red
d = [0,255,0] # Green
arrow = []
up_arrow = [ # Up arrow
    b,b,b,c,c,b,b,b,
    b,b,c,c,c,c,b,b,
    b,c,c,c,c,c,c,b,
    b,b,c,c,c,c,b,b,
    b,b,c,c,c,c,b,b,
    b,b,c,c,c,c,b,b,
    b,b,c,c,c,c,b,b,
    b,b,c,c,c,c,b,b,
    b,b,c,c,c,c,b,b]

down_arrow = [ # Down arrow
    b,b,d,d,d,d,b,b,
    b,b,d,d,d,d,b,b,
    b,b,d,d,d,d,b,b,
    b,b,d,d,d,d,b,b,
    b,b,d,d,d,d,b,b,
    b,d,d,d,d,d,d,b,
    b,b,d,d,d,d,b,b,
    b,b,b,d,d,d,b,b,b]

while True: # Main loop
    show_arrow = False
    p = sh.get_pressure() # Take pressure reading
    logging.info(str(p)) # Log value to file
    if p > p_old: # If pressure has increased...
        col = [255,0,0] # Set to red
        if (p - p_old) >= 1: # If change > 1mB
            show_arrow = True
            arrow = up_arrow
    else: # If pressure has decreased...
        col = [0,255,0] # Set to green
        if (p_old - p) >= 1:
            show_arrow = True
            arrow = down_arrow
    sh.show_message(str(round(p,2)),text_colour=col)
    if show_arrow:
        sh.set_pixels(arrow) # Draw arrow on LEDs
        sleep(0.5)
    p_old = p # Set previous value
```

Language

&gt;PYTHON 3

DOWNLOAD:  
magpi.cc/1LIZPdZ

program running and then disconnect the mouse, keyboard, and monitor. The pressure readings should now be scrolled across the Sense HAT LED matrix every half a second. If the value is higher than the previous one, the text will be red; if it's lower, green. If the change between readings is at least a millibar, then an arrow is also shown after the numerical value; a change of a millibar is reasonably significant over a small area.

Take your portable sensor for a walk and explore how pressure varies with your surroundings. You should notice a change if you take the Pi outside, especially if you have air conditioning inside. What differences do you see moving from upstairs to a lower floor? How about if you enter a big room with high ceilings, like a school hall?

You've probably noticed that the code uses another library called 'logging' and worked out that this is used to store every measurement in a file. Therefore you can leave your experiment running, see how pressure changes over a few days, and compare these with officially reported values from your regional meteorological office. Don't forget that the Sense HAT can also measure temperature and humidity. The data is written to a file called **pressure-<datetime>.log**, so you can import this straight into LibreOffice on the Pi and use it to plot some graphs.

## A little experiment

If you're too impatient and want to mess around with some quicker pressure changes, here's a simple experiment. A bicycle pump with a needle adapter for inflating sports balls is ideal for this, but a normal tyre adapter or a balloon pump will also work. Take a sealable sandwich bag and make a small hole in the side with the pointy bit of the pump, then use sticky tape to make an airtight seal around the input from the pump. Close up the normal end of the bag and check that you can inflate it like a balloon.

Now open the bag and pop the Pi, Sense HAT and battery pack into it. Seal it up again and start pumping. You should see the pressure measurements displayed on the LED matrix rise quite rapidly. Typically, you should be able to cause a rise in pressure of at least 5-10 millibars.

What is happening? You can see that as you start pumping, the volume of air in the bag increases and starts pushing the sides out. This is because we're increasing the amount (and therefore the total weight) of air in the bag, so that it's at a greater pressure than the air outside. If we sucked the air out of the bag, there would be greater pressure outside and the bag would crumple inwards.

It's worth remembering that there's roughly a ton of air pressing down on you all the time. You don't notice it because the force is exerted in all directions, balancing itself out.

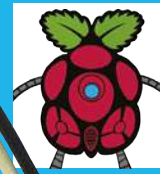

MODMYPi

A UK-based online distribution company selling the Raspberry Pi, along with a wide range of accessories. [modmypi.com](http://modmypi.com)

SPLITTING PIN HEADERS

The easiest way to split a pin header is to use a pair of pliers!

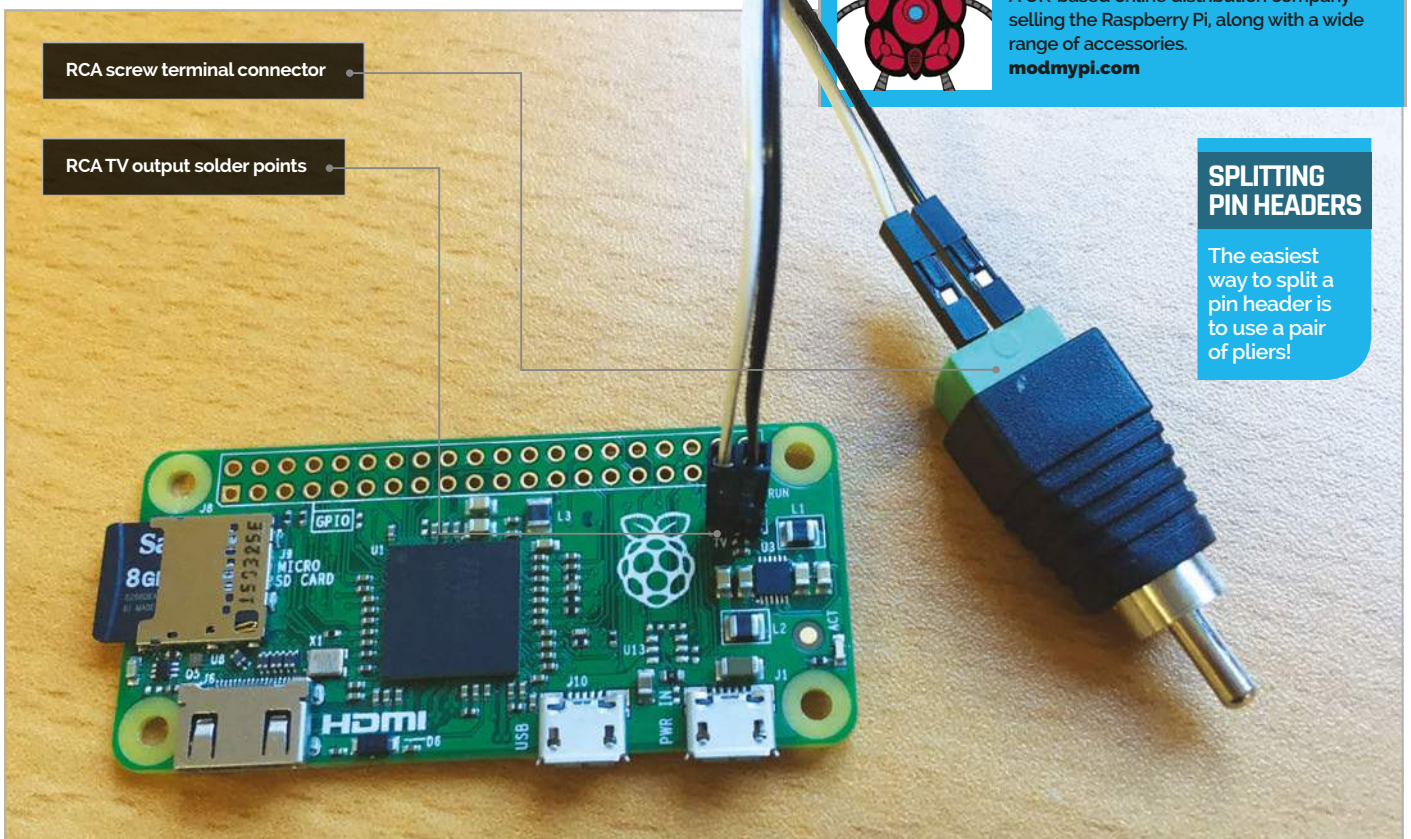

# RCA OUTPUT FOR YOUR PI ZERO

Did you know that the Pi Zero has a composite video out port which is very easy to access? If you'd like to connect your Zero to an old TV, read on and we'll show you how...

### You'll Need

- > Pair of header pins [magpi.cc/1U76ZW3](http://magpi.cc/1U76ZW3)
- > Male-to-female jumper wire [magpi.cc/1U774sY](http://magpi.cc/1U774sY)
- > Screw terminal RCA [magpi.cc/1U776AV](http://magpi.cc/1U776AV)

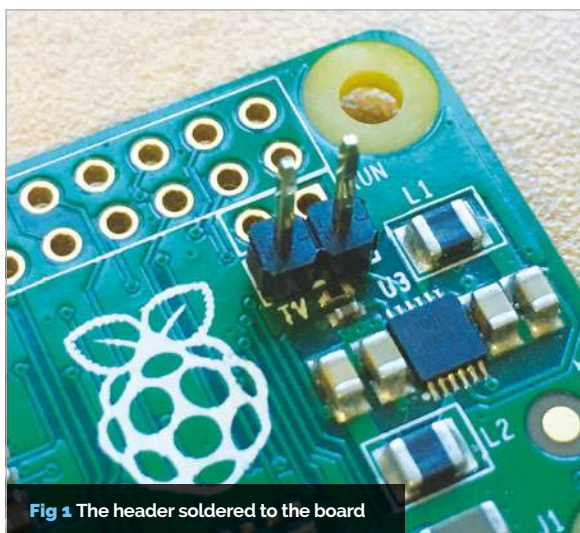

Fig 1 The header soldered to the board

In this simple, easy-to-follow tutorial, we'll be showing you how to hook up your Pi Zero to a TV via an RCA cable. That's right – believe it or not, the Pi Zero isn't limited to just HDMI video. By soldering a header pin, hooking up a couple of jumper wires, and adding a screw terminal RCA connector, you can easily access the RCA video output so you can use an old CRT TV in your next Raspberry Pi project.

We're going to be soldering two pin headers onto the Pi Zero. Start by soldering a pin header to the square pad labelled 'TV' on your Pi, then solder another header onto the circle pad next to the square pad. Both pads are contained within a white outline. See Fig 1 for reference.

You could solder wires directly to these pins, but by using pin headers you get a nice neat solution that



allows your connection to be removed when required. Once the headers have been soldered to your Pi, you can then move on to attaching the jumper wires to your RCA screw terminal. Using the male side of the jumper wire, attach them to each of the terminals, making sure to screw them up nice and tight. Make a note of which wire is plugged into the positive pin and negative pin.

Now plug each of the wires into the pin headers you previously soldered onto your Pi. Make sure the wire connected to the positive terminal is connected to the pin labelled 'TV'.

That's it for setting up the hardware. Now your Pi should automatically detect which video method you're using, either HDMI or RCA. If it doesn't, however, read on and follow our software configuration to get it working.

## Setting up the software

First things first: either SSH into your Raspberry Pi, or open up a terminal window.

We need to make some changes to the `config.txt` file, but before we do that it's probably a good idea to make a backup of the original, just in case:

```
sudo cp /boot/config.txt /boot/config.txt_backup
```

Now we have our backup, we can edit the original and make some changes. Start by opening `config.txt` in your editor of choice. We'll be using nano:

```
sudo nano /boot/config.txt
```

There are two lines in the file that you need to edit. Firstly, you need to remove the comment '#' from the following line:

```
#sdtv_mode=2
```

So it should now look like this:

```
sdtv_mode=2
```

Then we need to add a comment '#' to the following line:

```
hdmi_force_hotplug=1
```

So it should now look like this:

```
# hdmi_force_hotplug=1
```

That's it. Remember to save your file – if you used nano, press **CTRL+X** to exit; then, when asked if you want to save changes, enter **Y** then press **RETURN**.

Now you can plug your RCA cable into your TV/monitor, and you should hopefully see the video output. Happy days!

The project requires very few components

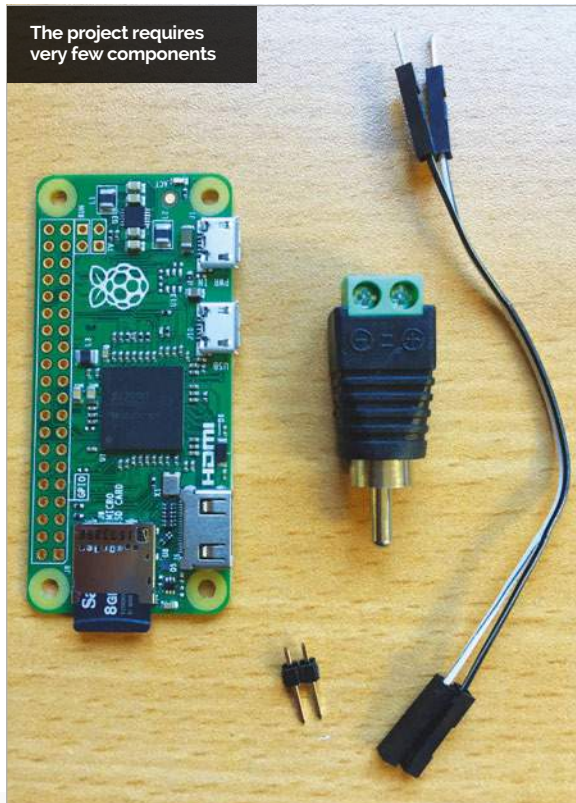

### SOLDERING PIN HEADERS

Try putting the pin headers in a breadboard to hold them upright!

### TYPING FILE PATHS

When typing file paths in the terminal, try pressing **TAB** to auto-complete!



Hook it up to a video input

# MIKE'S PI BAKERY



MIKE COOK

Veteran magazine author from the old days and writer of the Body Build series. Co-author of *Raspberry Pi for Dummies*, *Raspberry Pi Projects*, and *Raspberry Pi Projects for Dummies*. [magpi.cc/1NqldHU](http://magpi.cc/1NqldHU)

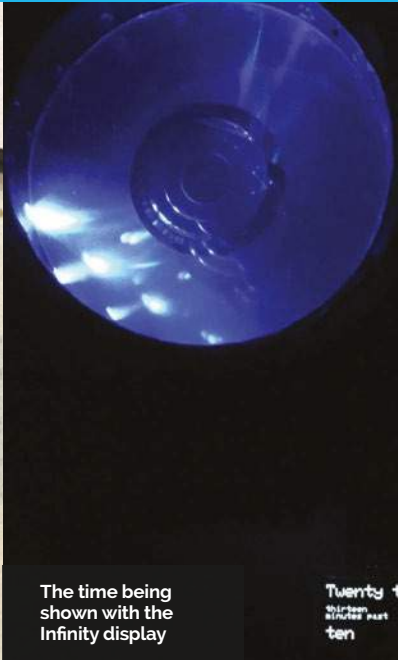
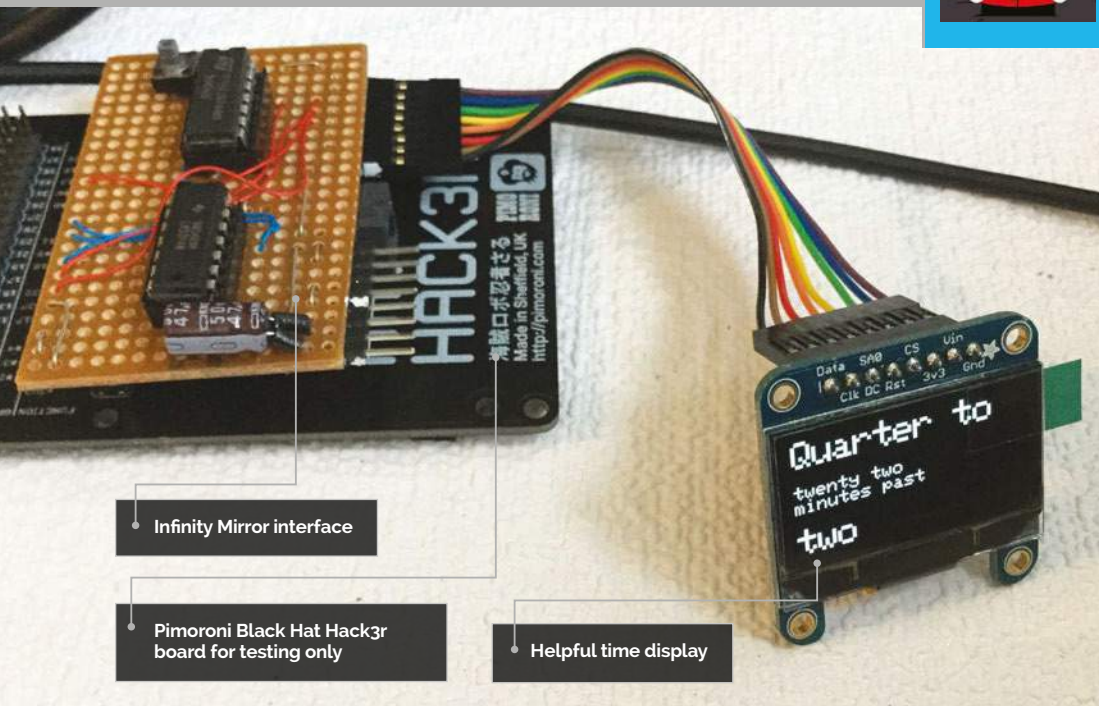

Infinity Mirror interface

Pimoroni Black Hat Hack3r board for testing only

Helpful time display

The time being shown with the Infinity display

Twenty to  
twenty minutes past  
ten

## You'll Need

- > Infinity Mirror from *The MagPi* issue 43
- > 128x64, 1.3" monochrome OLED display
- > USB WiFi module
- > Micro USB to standard USB adapter
- > Connectors and leads

# INFINITY MIRROR

## PART 2 Add a quirky time display to your Infinity Mirror

Last month in the Pi Bakery, we showed you how to make an Infinity Mirror using the Pi Zero. This month, we add a time display with a difference. Have you noticed how technology promises to make your life easier, but most of the time it adds layers of complications? Well, this time display is different: it promises to make your life more difficult and it delivers on that promise! This display tells you the time in words, but it leaves you with a bit of work to do. This sort of time check is much beloved by fans of BBC 6Music's breakfast show with Shaun Keaveny, who calls it a 'rubbish time check'. It's just the thing to get your brain working in the morning.

### The project

The idea is to take the time from a network connection, translate it into words and show it on the OLED display. This is incorporated into the Infinity Mirror so that each time the distance sensor detects a change in the distance to someone in front of the mirror, a new time – or version of the time – will be displayed. When there's nothing in front of the mirror, then no time is displayed.

Normally, time is expressed as some time to or past the hour. Here there's another layer, with the time being expressed as some time to or from... some time to or from the hour. This first time is quantised into five-minute intervals, whereas the second time is not.



As an example, if the time is two minutes past twelve, then it could be expressed as 'twenty-five to twenty-seven minutes past twelve'. The same time could be expressed in a number of different ways, all depending on how the first time is expressed. Note that the words follow the syntactic rules of English; for example, you can say half past but never half to, like you can in some other languages.

## The design

Basically, you just need to add on the OLED connections to last month's project – the connections required are shown in **Fig 1**. Note that as this uses the SPI interface, there is little leeway in the pins you can use. See the 'Fitting the OLED display' step-by-step boxout for full details of the construction. When completed, the display shines through the mirror.

## The software

The first thing you need to do is to install the drivers for the display. Full step-by-step instructions can be found in this Adafruit guide: [magpi.cc/1UfLkKL](http://magpi.cc/1UfLkKL).

The display interfaces through SPI, and there's a bit of Linux-fu you need to enable this interface that's fully described in that link. However, in use it's quite straightforward – it's basically a print statement giving the X and Y coordinates of where you want to print, and the string you want to print. The difficulty is in making it print what you need. The **hard\_time.py** listing (overleaf) shows a standalone program that will print the time in this quirky format. The time is taken from the network interface using the **time.strftime("%X")** method. The **draw\_text2** method takes a parameter that will determine the text size – we used double-size text for the initial time to/from and for the hour, and single-size text for the other stuff. A random number determines the initial from/to and a quantised offset. The code then works out how far away from this offset the real time is, and prints it out in words.

## FITTING THE OLED DISPLAY



### >STEP-01

#### Connecting to the Pi

We used a right-angled eight-way pin header soldered on the underside, and a straightforward eight-way ribbon connector to connect to the display. Fortunately, we made space on the left-hand side of the board last month for this. Cut a hole in the Infinity Mirror backing foam to fit the OLED display on the left side of the Pi Zero.

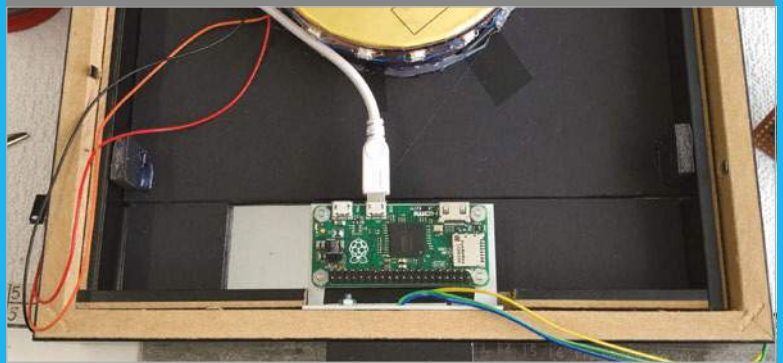

### >STEP-02

#### WiFi attachment

In order to receive the accurate time, attach a WiFi dongle to the Pi Zero's USB port with an adapter lead. Set up the WiFi on the B+ before transferring the SD card to the Pi Zero.



Fig 1 Connecting the OLED display to the Raspberry Pi

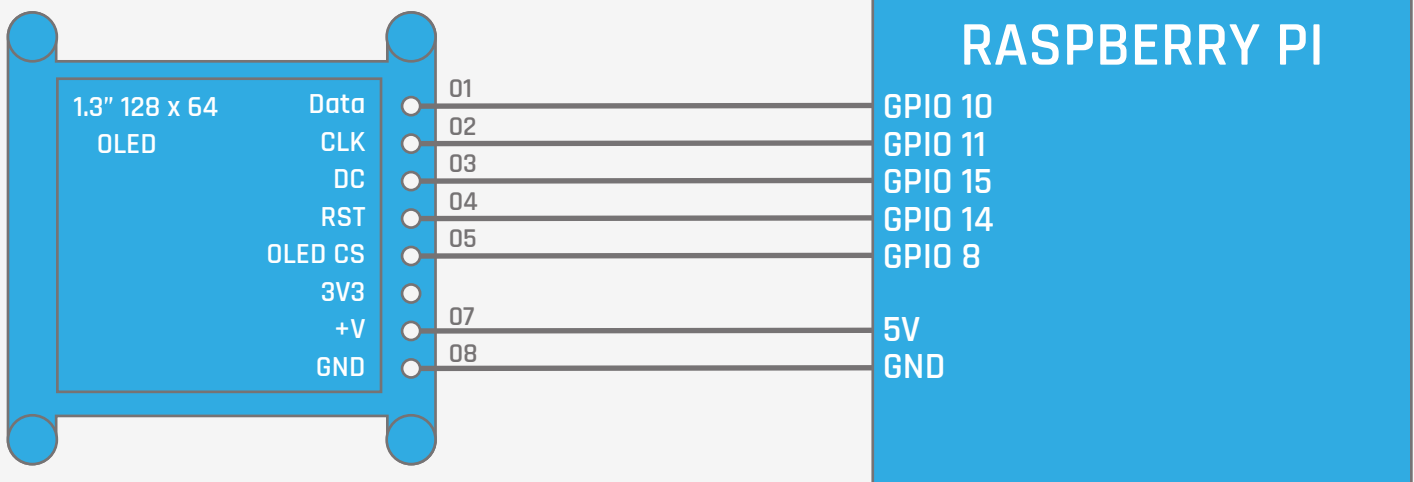

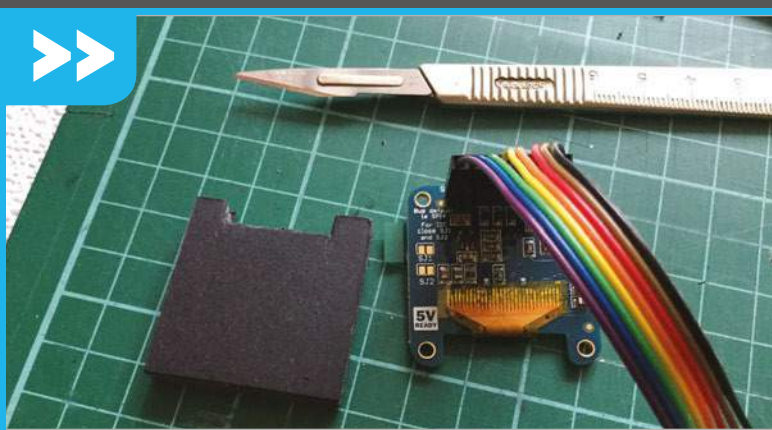
**>STEP-03****Cut out the foam backing**

Use the foam mounting board you cut out of the Infinity Mirror backing and cut out an additional notch to allow the OLED connector to poke through. Remove the protective film from the front of the display and place it directly on the mirror. Place the foam square on top and tape or hot-melt glue it to the surrounding foam.

**Integrating with the mirror software**

Unfortunately, there's a bit of a problem with the software we used last month. At the Bakery, we always get software to access the GPIO using the real (BCM) GPIO pin numbers. The writer of the OLED drivers took the opposite approach and used the 'fake' pin numbers from the pre-production drawings. As the wiringPi driver can't work in two modes at once, something had to give. Therefore, in order for the distance sensor to be used with the OLED display, we need to switch modes. Fortunately, this involves changing only three lines from last month's code:

```
io.wiringPiSetup() # the wiringPi pin mode
```

```
sensorPins = [0,5,4,2] # these have to be  
in the WPI mode
```

```
shutDownPin = 25 # this has to be in the  
WPI mode
```

These define the mode and what pin numbers to use. Now add in all the functions and code from the `hard_time.py` listing, with the exception of the main function to last month's code, and replace the `checkForDistance()` function with the one in the `Integration.py` listing. Alternatively, see our GitHub repository ([magpi.cc/1NqJjmV](https://github.com/magpi/cc/1NqJjmV)) for it all in one.

**Taking it further**

You can change the code so it updates the time displayed every so often, instead of when the display pattern changes. Or you can alter the code so it says the words in a less convoluted fashion. You can also have a more conventional clock-like display; there is code to do this in our GitHub repository.

***hard\_time.py***

```
01. # Hard time standalone - Magic mirror
02. # By Mike Cook - February 2016
03.
04. import time, os, random
05. import gaugette.ssd1306
06.
07. random.seed()
08. numberText = ["zero", "one", "two",
09. "three", "four", "five", "six",
10. "seven", "eight", "nine", "ten",
11. "eleven", "twelve", "thirteen",
12. "fourteen", "fifteen", "sixteen",
13. "seventeen", "eighteen", "nineteen"]
14. upperNumberText = ["teen", "twenty",
15. "thirty", "forty", "fifty"]
16. pastText = [ " ", "Five", "Ten", "1/4",
17. "20", "25", "Half"]
18. pastTextFull = ["nothing", "five", "ten",
19. "quarter", "twenty", "twenty five",
20. "half"]
21. toText = [ " ", "Five", "Ten", "Quarter",
22. "Twenty", " 25", " Half"]
23. RESET_PIN = 15
24. DC_PIN = 16
25. ROWS = 64
26.
27. display = gaugette.ssd1306.
28. SSD1306(reset_pin=RESET_PIN, dc_pin=DC_
29. PIN, rows = ROWS)
30. display.begin()
31. display.clear_display()
32.
33. def main():
34.     print "Time test"
35.     while True:
36.         timeText = time.strftime("%X")
37.         print timeText
38.         printHardTime(int(timeText[0:2]), in
39. t(timeText[3:5]) )
40.         print
41.         time.sleep(5.0)
42.
43. def printHardTime(hardH, minsR):
44.     display.clear_display()
45.     offset = 0
46.     past = True
47.     if(random.randint(0,10) > 5) :
48.         past = False
49.     if(past) :
50.         offset = random.randint(1, 6)
51.     else :
52.         offset = random.randint(1, 5)
53.     if(past) :
```



Language

&gt;PYTHON 2.7

DOWNLOAD:  
magpi.cc/1NqJjmVPROJECT  
VIDEOSCheck out Mike's  
Bakery videos at:  
magpi.cc/1NqJnTz

```

42.     display.draw_text2(
43. 0,0,pastText[offset]+" past",2)
44.     hardM = minsR - (offset * 5)
45.     if hardM < 0 :
46.         hardM +=60
47.         hardH -= 1
48.         if(hardH < 1) :
49.             hardH = 23
50.     printTimeW(hardH,hardM);
51.     else :
52.         display.draw_text2(
53. 0,0,toText[offset]+" to",2)
54.         hardM = minsR + (offset * 5)
55.         if(hardM >= 60) :
56.             hardM -=60
57.             hardH += 1
58.             if(hardH > 23) :
59.                 hardH = 1
60.         printTimeW(hardH,hardM)
61.     display.display();
62. def printWords(number,y,s):
63.     if(number < 20):
64.         display.draw_text2(0,y,numberText[number],s)
65.         return
66.     else :
67.         display.draw_text2(0,y,upperNumberText[(
68. number-10) / 10]+" ",s)
69.         if number % 10 != 0 :
70.             n = len(upperNumberText[(
71. number-10) / 10]+" ")*6
72.             display.draw_text2(
73. n,y,numberText[number% 10],s)
74. def printTimeW(h, mins):
75.     past = True
76.     if(h > 12) :
77.         h -= 12
78.     if(mins > 30):
79.         mins = 60 - mins;
80.         # test for seconds being mins
81.         h += 1
82.         if(h > 12) :
83.             h = 1
84.         past = False
85.     if((mins % 5) == 0) :
86.         if(mins != 0):
87.             # time is on a 5 min interval
88.             display.draw_text2(
89. 0,24,pastTextFull[mins / 5],1)
90.             if( past ) :
91.                 display.draw_text2(0,32,"

```

```

92.         display.draw_
93. text2(0,32," to ",1)
94.         printWords(h,48,2)
95.         else : # time is on hour
96.             printWords(h,48,2)
97.             else :
98.                 printWords(mins,24,1)
99.         # minutes
100.         if( past ) :
101.             if(mins == 1):
102.                 display.draw_text2(
103. 0,32,"minute past ",1)
104.             else :
105.                 if(mins == 1) :
106.                     display.draw_text2(0,32,"minute to ",1)
107.                 else :
108.                     display.draw_text2(0,32,"minutes to ",1)
109.                 printWords(h,48,2)
110.             # Main program logic:
111.             if __name__ == '__main__':
112.                 main()

```

## Integration.py

```

def checkForDistance():
    global pattern, patternStep
    if io.digitalRead(sensorPins[0]) == 1 :
        if pattern != 0: # if something showing
            wipe()
            pixels.show()
            pattern = 0 # stop any display
            patternStep = 0 # put to start of a pattern
            display.clear_display() # wipe time display
            display.display()
        else :
            close = 0
            for n in range(1,4):
                if io.digitalRead(sensorPins[n]) == 0 :
                    close = n
            if pattern != close+1 : # has pattern changed
                pattern = close+1
                patternStep = 0 # stage in pattern
                timeText = time.strftime("%X")
                printHardTime(
                int(timeText[0:2]),int(timeText[3:5]) )
                #print"now showing pattern ",pattern

```



**BERNAT ESPIGULÉ PONS & BRETT HAINES**

Bernat and Brett are both employees at Wolfram Research. [wolfram.com](http://wolfram.com)

The Wolfram Language offers direct access to the Camera Module, making image capturing easy

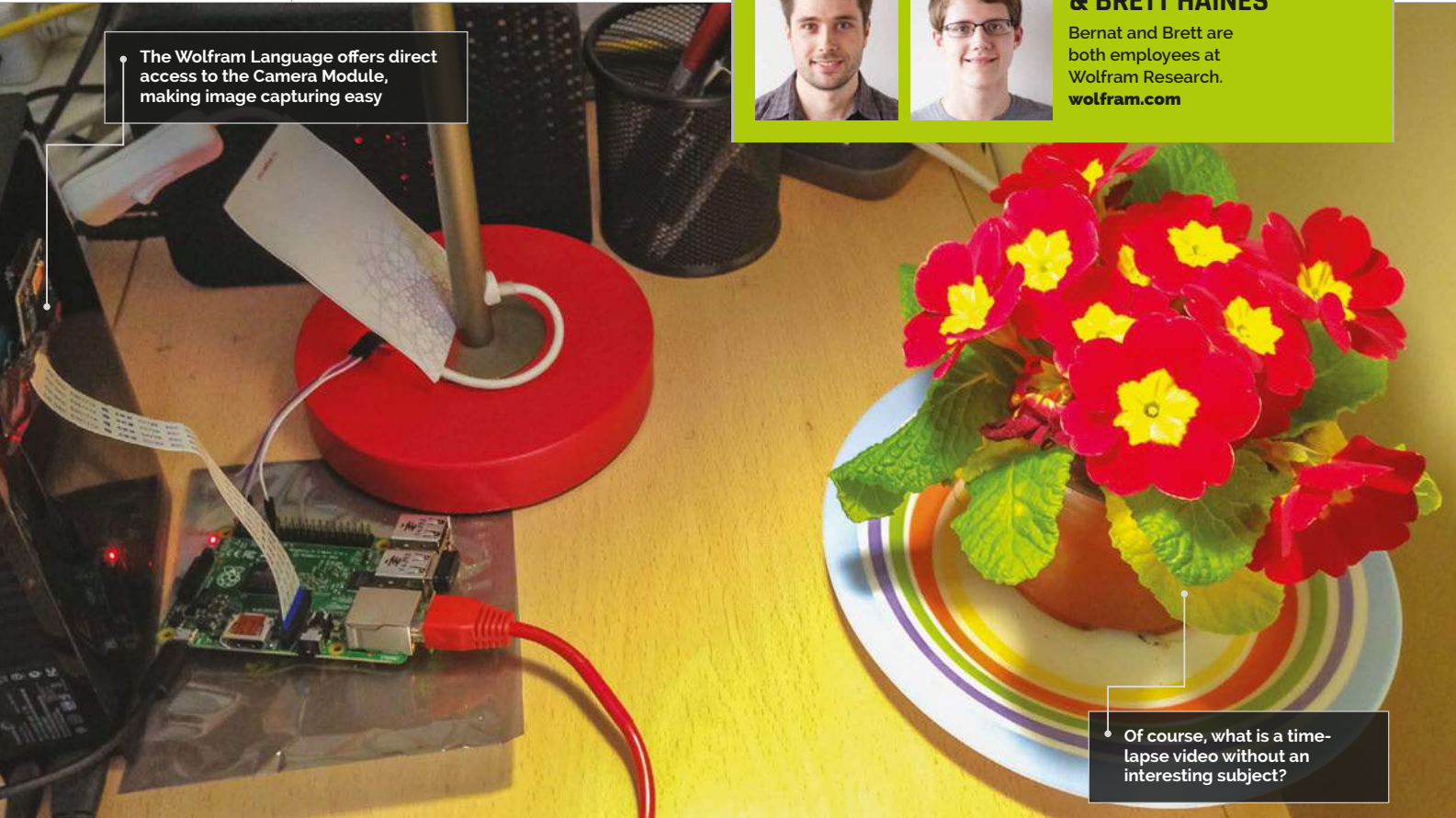

Of course, what is a time-lapse video without an interesting subject?

# MAKE TIME-LAPSE VIDEOS WITH YOUR RASPBERRY PI & DATA DROP

With the Raspberry Pi camera, the Wolfram Language makes it easy to record many pictures over a period of time, then compose them into a video

## You'll Need

- > Data Drop account [magpi.cc/1UaFtH7](http://magpi.cc/1UaFtH7)
- > Raspberr Pi Camera Module [magpi.cc/1UaFuuW](http://magpi.cc/1UaFuuW)

**I** magine the ability to see the progress of a plant's growth over a few days in seconds. With the Wolfram Language, you don't have to imagine! When paired with the Raspberry Pi Camera Module, the Wolfram Language can use a ScheduledTask object to automatically take pictures on a set schedule. Then, with the Wolfram Language's powerful image manipulation capabilities, these images can be strung together to form a single animated image in the form of a GIF. As the pictures are being taken, Wolfram's Data Drop service will be used to store them.

### >STEP-01 Camera setup

Set up your Camera Module. We stuck ours onto a hard drive, but anywhere with adequate lighting is fine. Take a test shot to make sure that the exposure is acceptable.

```
cam = DeviceOpen["RaspiCam"]
DeviceRead[cam]
```

### >STEP-02

#### Adjust images with Wolfram Language

If the images are hard to see, or you're just really particular about pictures, the Wolfram Language can be used to adjust them. The easiest method is to use the ImageAdjust function, which automatically adjusts the lightness and darkness of an image to even it out. You can read about more image manipulation functions in the Images section of [reference.wolfram.com](http://reference.wolfram.com).

```
ImageAdjust[DeviceRead[cam]]
```

### >STEP-03

#### Create a new databin

At this point, you'll need to set up a Wolfram ID. You may already have one if you use Wolfram|Alpha or Data Drop. Go to [datadrop.wolframcloud.com](http://datadrop.wolframcloud.com) and either sign in or register (if necessary). Using the same email and password used to sign



Language  
> WOLFRAM

in online, you can connect your open instance of the Wolfram Language to your account. This will enable you to easily pass images to Data Drop. Once your account is connected, use the CreateDatabin function to make a new databin, in which you can store any type of data you can create. For now, we'll just store the images taken by the Camera Module.

```
CloudConnect["email-wolframID", "password"];
bin=CreateDatabin[]
```

>STEP-04  
Set up a ScheduledTask

RunScheduledTask is a very powerful function in the Wolfram Language. Much like a cron job in Unix systems, it allows a function (or set of functions) to be run periodically. The first parameter in RunScheduledTask is the function we want to run, and the second is the amount of time in seconds the ScheduledTask will wait between runs.

```
intervalometer=RunScheduledTask[DatabinAdd[bin, ImageAdjust[DeviceRead[cam]]],360]
```

>STEP-05  
Wait!

Since we've set up the Wolfram Language to run automatically, we can just sit back and let the Raspberry Pi do all the work. You can take this time to read about more Wolfram Language functions at [reference.wolfram.com](http://reference.wolfram.com), or read the rest of this issue of *The MagPi*.

>STEP-06  
Check your databin

Make sure that the images being taken on the Pi are being sent to Data Drop correctly. One example of how it should appear is at [wolfr.am/3GgU-jf4](http://wolfr.am/3GgU-jf4), which is the databin we have used writing this tutorial. Your images should be stored in a different databin attached to your own account. You can see it by clicking on the 'My Databins' link in the upper-right corner of the Data Drop page after signing in.

>STEP-07  
Compile the animated GIF

Using the Values function, we'll load all of the images stored in the databin with the pictures. Then we'll use the Export function to create a GIF with all of these images.

```
frames = Values[bin];
Export["resurrected_plant.gif", frames]
```

RasPiCamTime  
LapseCode.m

```
cam = DeviceOpen["RaspiCam"]
DeviceRead[cam]

ImageAdjust[DeviceRead[cam]]

CloudConnect["email-wolframID", "password"];
bin=CreateDatabin[]

intervalometer=RunScheduledTask[DatabinAdd[bin, ImageAdjust[DeviceRead[cam]]],360]

frames = Values[bin];
Export["resurrected_plant.gif", frames]
Export["resurrected_plant_2.gif", Join[frames, Reverse[frames]]]

StopScheduledTask[intervalometer]
```

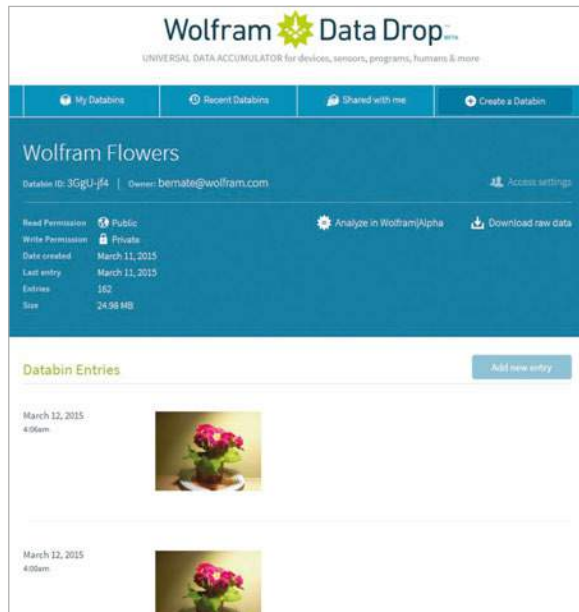

Left This is how the Wolfram Language displays a databin object, which contains the images we are using

If you want to get a little more complex, you can use the Reverse function on the set of images to animate the pictures in reverse order as well.

```
Export["resurrected_plant_2.gif", Join[frames, Reverse[frames]]]
```

>STEP-08  
Stop the ScheduledTask

The ScheduledTask we started earlier will continue to run indefinitely, so we need to stop it with the StopScheduledTask function.

```
StopScheduledTask[intervalometer]
```

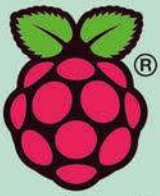

In association with Raspberry Pi

Will you witness the reveal?

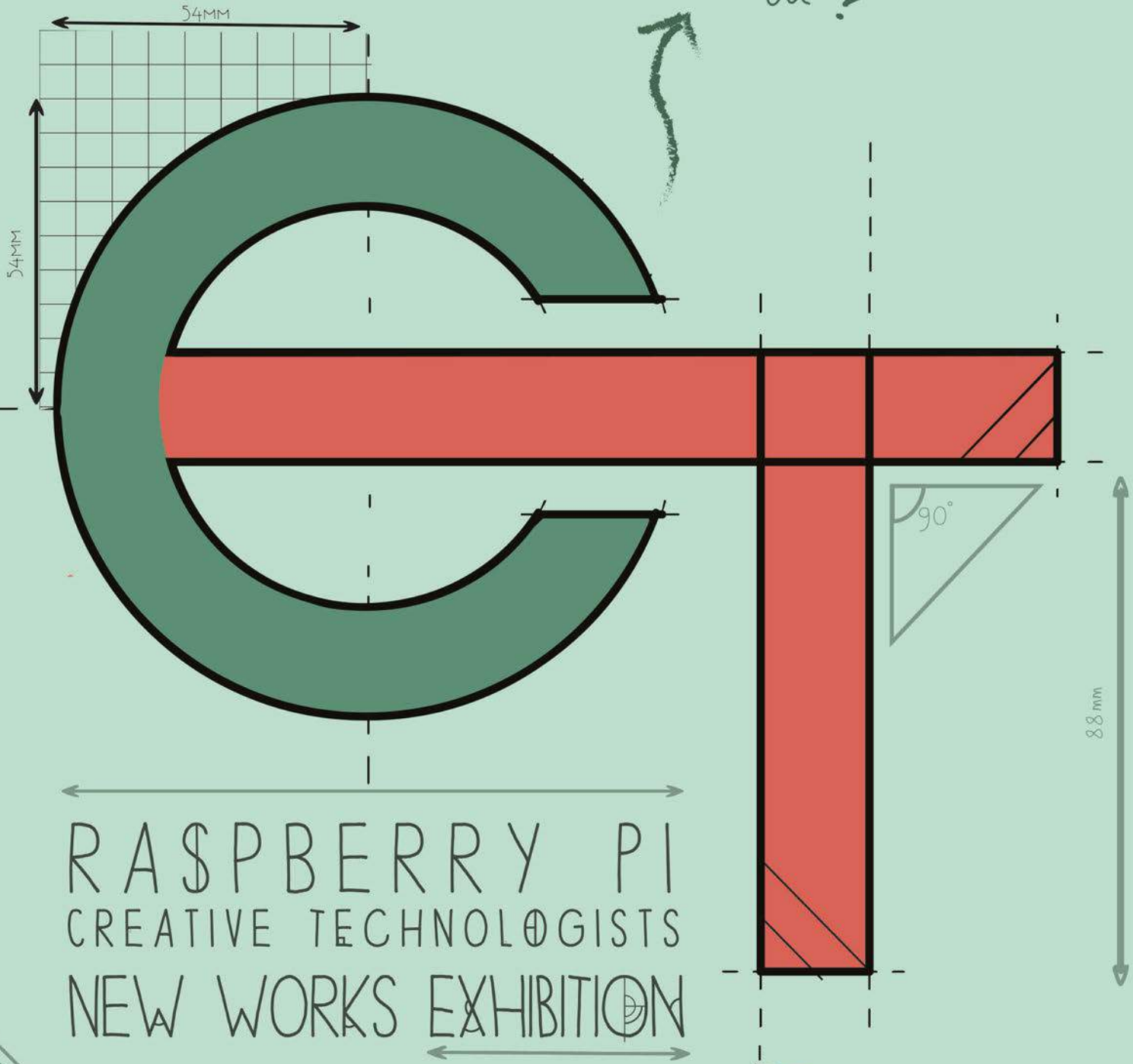

@RasPiCT

www.RPCT.io

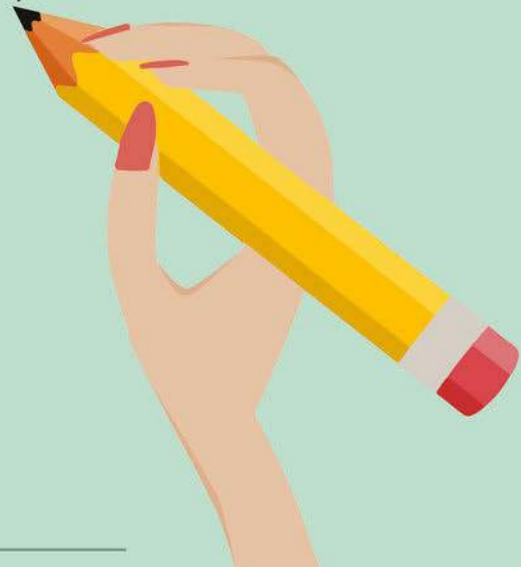
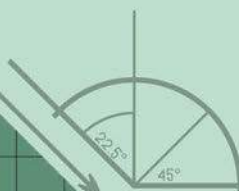





# 9 YOUNG INDIVIDUALS

with varied skillsets working alongside Raspberry Pi and industry professionals to create unique and equally awesome projects

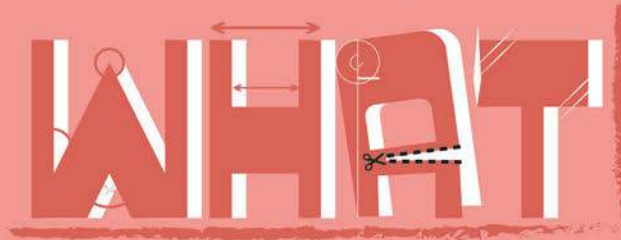

# AN EXHIBITION

That showcases the accomplishments of a years hard work and shows how diverse technology can be when it comes to being creative



RASPBERRY PI HQ

30 Station Road, Cambridge  
CB1 2RE



# ART MEETS TECH

We want to show that art can be created through technology to make more interesting and immersive projects.



23RD APRIL 2016

# JAMES BOND SPY PROJECTS

Come in, Bond, and please be careful. We have the very latest in spy technology ready for your next mission

**R**ight, now pay attention 007: we have gathered some special projects, all made using the best of British microcomputer technology – our beloved Raspberry Pi.

Our agents in the field have been working with the Raspberry Pi components, and have been creating experimental spy projects that can foil even the craftiest double agents.

If you want to eavesdrop on a conversation, well, we've got just the thing: a light bulb that can surreptitiously transcribe spoken dialogue. On the other hand, if you're worried about your voice being detected, our voice distortion box will help you out.

Or if you prefer the visual approach, why not build a classic spy camera? Our pinhole cameras can be hidden in any location, or you can wear our bow tie spy camera. No, I never joke about my work, 007.

If you want to find out where somebody is heading, make sure you set up our GPS tracker. We even have motion detection cameras for long-range spying, and a Raspberry Pi-powered Geiger counter for those trickier missions. Self-respecting secret agents should keep their equipment out of sight, so we've got a computer that hides inside your lunch box.

Need I remind you, 007, that you have a licence to kill, not to break the law? Do not use this equipment for nefarious purposes. This is a training mission only, so please remember to spy on operatives who are part of your assignment and not random members of the public. Good luck out there in the field, Mr Bond, and do please try to return the equipment in one piece this time.

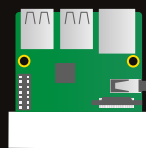





# [TOP SECRET]

## AUDIO SPYING.....{68}

Conversnitch is a network-enabled listener that plugs into a light socket and listens in to conversations. The Raspberry Pi transcribes the words to text and shares them.

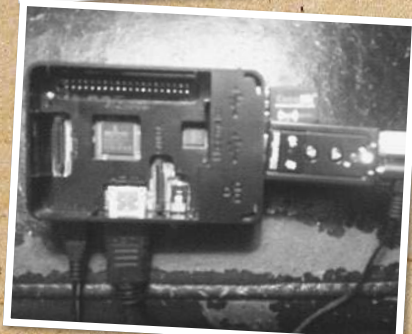

## VOICE CHANGER.....{68}

Use the Raspberry Pi Voice Distorter to change the sound of your voice. Perfect for keeping your secret identity intact.



## HIDDEN CAMERA.....{71}

Pinhole spy cameras can be placed anywhere, but the boldest secret agents will wear a hidden camera.

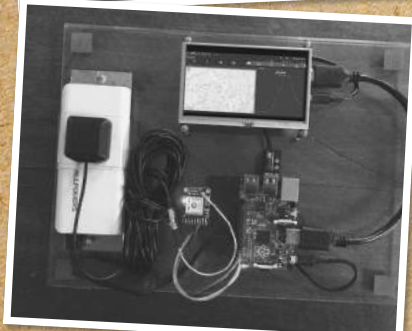

## GPS TRACKER.....{72}

Don't lose track of your suspects. Attach a GPS device to a Raspberry Pi and you can follow people around from a distance.

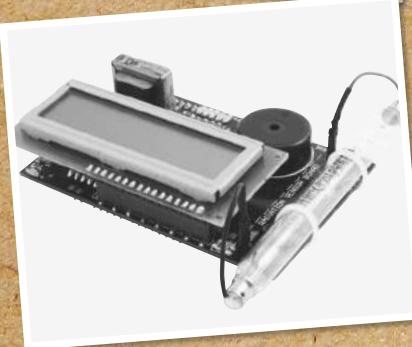

## GEIGER COUNTER.....{73}

Nuclear radiation can be deadly, and you never know when some is around. Our Geiger counter is vital on those more dangerous missions.



## [MAKER PROFILE]



BRIAN HOUSE  
& KYLE MCDONALD

Brian House is a fellow at the Tow Center for Digital Journalism at Columbia University; Kyle McDonald is an artist who works in the open with code, and an adjunct professor at NYU's ITP (Interactive Telecommunications Program).  
[magpi.cc/1QRSep8](http://magpi.cc/1QRSep8)



# CONVERSNITCH

This Raspberry Pi device plugs into a light socket and listens to conversations. These are then transcribed and shared on Twitter

### You'll Need

- ▶ Raspberry Pi
- ▶ Microphone
- ▶ WiFi dongle
- ▶ Light socket adapter

**C**onversnitch is one of the coolest spy devices we've seen created using a Raspberry Pi. Created by two Brooklyn-based artists, it impersonates a light bulb and records nearby conversations. These audio recordings are then sent to Amazon's Mechanical Turk program and are cheaply transcribed by hand.

Kyle McDonald and Brian House created the device to raise questions about the nature of public spaces, but it's certainly one of the most impressive spy devices we've seen.

Conversnitch costs less than \$100 to build. The parts are simple: it uses a Raspberry Pi board, microphone, and a WiFi dongle. An Edison screw light bulb fitting is hacked to provide power to the Raspberry Pi, and the whole unit is housed in a plastic circular case.

Bryan House explains: "The device continually records ten-second snippets of audio, analyses them for potential voice content, and sends promising files to Mechanical Turk for transcription. The system then posts these transcriptions to Twitter."

A video showing the build process is available on Vimeo ([vimeo.com/87564506](http://vimeo.com/87564506)) and all of the source code is on GitHub ([magpi.cc/1QRRSin](http://magpi.cc/1QRRSin)).

Conversnitch is a frighteningly easy project to put together. Perhaps the hardest part would be hacking a light bulb connection to provide power to a Raspberry Pi, although devices like the GE Socket Adapter or Leviton 2-Outlet Socket make life much easier.

Getting people to be more aware about the laws that are in place to protect us is the aim, reveals Kyle. "Some artists, like Brian and myself, see it as their responsibility to make work that's about culture right now. Security and surveillance are one of the main topics we're dealing with.

"I hope that what happens is that people become scared and frustrated, and more aware of the laws around privacy and wiretapping, just by having something to look at.

"Conversnitch automatically tweets overheard conversations, bridging the gap between (presumed)

## VOICE CHANGER

Your voice is a dead giveaway, so why not add to your disguise with a voice changer? We love Dave Shevett's Raspberry Pi Realtime Voice Changer ([magpi.cc/1pvwGID](http://magpi.cc/1pvwGID)). Dave built it as part of his Technomancer costume for Halloween. "One thing I've always wanted was a voice changer that would let me have a nice sepulchral voice to go with the creepy visage," says Dave. The

project combines a Raspberry Pi with a USB sound adapter and Pyle Audio portable PA ([pyleaudio.com](http://pyleaudio.com)). A script uses ALSA ([alsa-project.org](http://alsa-project.org)) to record and play back audio in real-time. There is a slight delay of around a tenth of a second, but some hacks can reduce the delay.





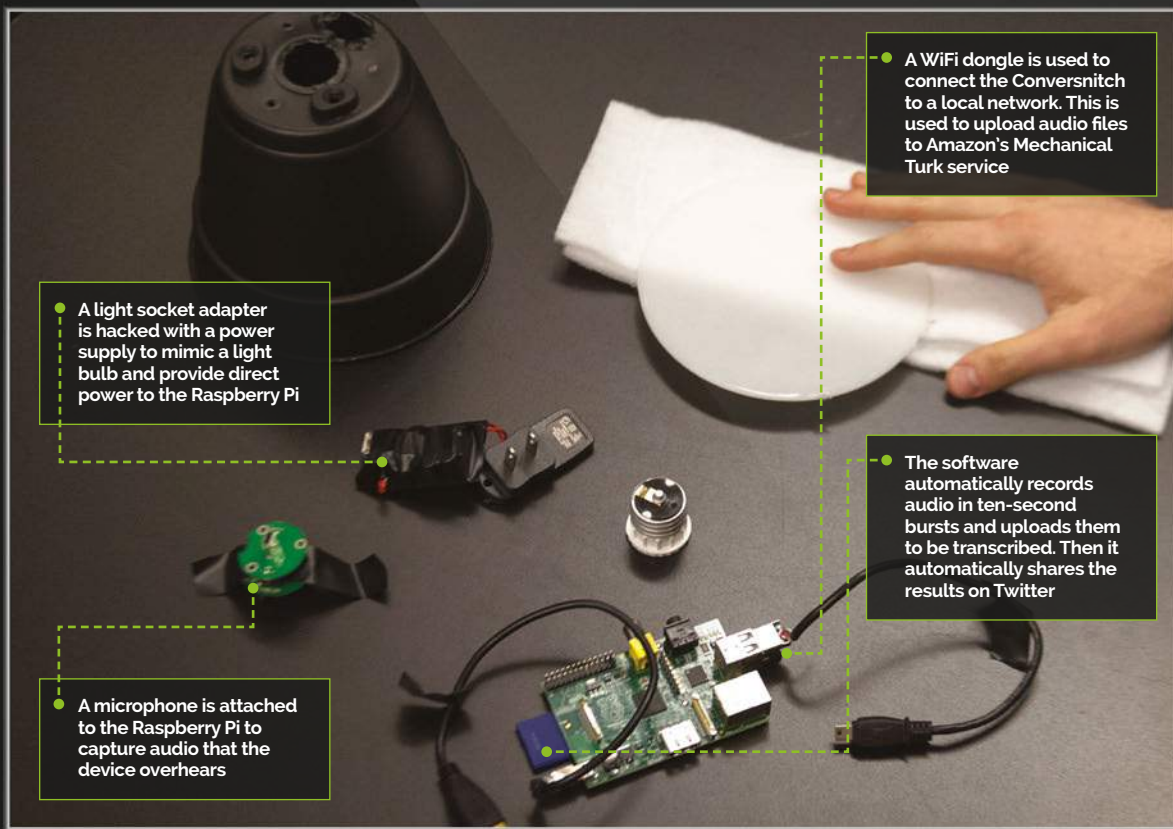

● A light socket adapter is hacked with a power supply to mimic a light bulb and provide direct power to the Raspberry Pi

● A WiFi dongle is used to connect the Conversnitch to a local network. This is used to upload audio files to Amazon's Mechanical Turk service

● The software automatically records audio in ten-second bursts and uploads them to be transcribed. Then it automatically shares the results on Twitter

● A microphone is attached to the Raspberry Pi to capture audio that the device overhears



private physical space and public space online,” Kyle explains.

Once assembled, the small light bulb plugs into any standard Edison screw fixture, and will connect to a local WiFi network – in demonstrations, it was set up in coffee shops. The audio from the microphone is streamed to Amazon’s Mechanical Turk ([mturk.com](http://mturk.com)) service, where it is transcribed by anonymous workers. Mechanical Turk specialises in HIT (Human Intelligence Tasks); these are low-cost, short tasks that are performed by humans around the world. In this case, they quickly translate the recorded snippets of audio to text.

Once the hardware is assembled, the Raspberry Pi continuously records ten-second samples and analyses them for interesting audio. If it finds some, it uploads the audio to an Amazon S3 bucket and reports to the server. The server then creates an MTurk HIT task with a link to the audio. A cron process then checks the HITs for completion and, if it finds one, posts the result to Twitter.

According to the project’s README.md document, “Conversnitch complicates the divisions between the physical and virtual, illegal and playful, human and machine, spoken and textual, exposure and illumination.”

## SPY CAMERA

There are lots of projects around for creating surreptitious spy cameras, and it really couldn’t be easier. The Raspberry Pi Camera Module is small enough to go undetected in many situations, and with a bit of concealment can be hidden in all kinds of ways. We like Raymond Wong’s Spy Bow Tie ([dai.ly/x2pjw8u](http://dai.ly/x2pjw8u)) and Tetranitrate’s Spy Shirt ([magpi.cc/1QRSh4o](http://magpi.cc/1QRSh4o)). If you want something truly inauspicious, then Adafruit’s Spy Camera ([magpi.cc/1pvuXwM](http://magpi.cc/1pvuXwM)) is much smaller than the regular Camera Module. It can be hidden inside clothing, so long as there’s a pinhole for the camera to see out. They’ll never spot you recording.



### You'll Need

- > Custom lunch box
- > 10,000 mAh USB battery
- > Raspberry Pi 2 with micro SD card
- > Clear Raspberry Pi case
- > 5-inch LCD
- > Bluetooth keyboard
- > 6,800 mAh 2v rechargeable battery
- > USB cables

# LUNCH BOX COMPUTER

Hide your Raspberry Pi where nobody will think to look... inside your lunch box

No secret agent outfit is complete without a briefcase, and no spy's briefcase is complete without a stash of secrets.

There are lots of Raspberry Pi computer projects around, but we think you'll admire this Lunch Box Computer by the cryptically named hacker, D10D3. It has all the components you need to run Raspberry Pi code on the move, and hides your Pi safely inside an inconspicuous box. It's ideal for places where computers are not allowed, and impromptu hacking projects.

## [MAKER PROFILE]



### D10D3

A maker, a hardware and software hacker, an artist, and general dreamer. He has an insatiable need to build things and modify them. He's a lover of science fiction, fantasy, cyberpunk, comic books, computers, and role-playing games. In short, he's a geek and a jack of all trades. [magpi.cc/1QRSkWR](http://magpi.cc/1QRSkWR)

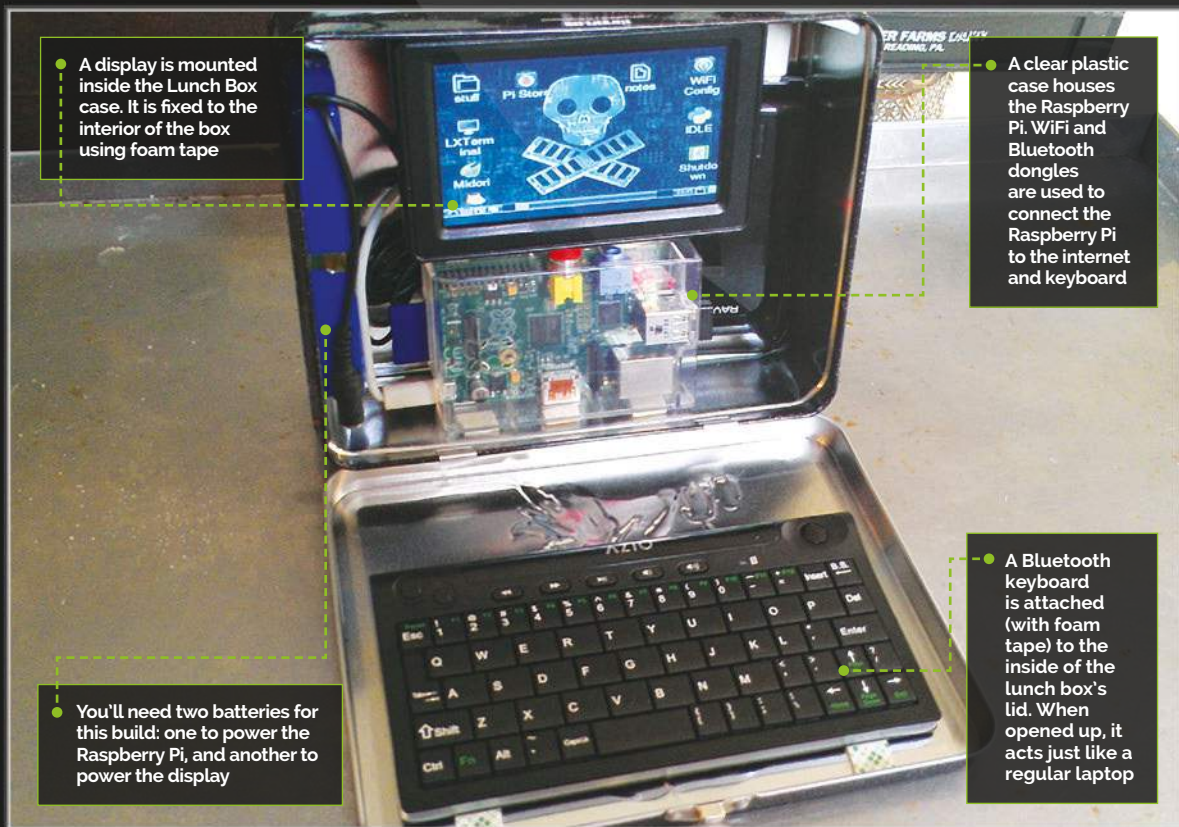

A display is mounted inside the Lunch Box case. It is fixed to the interior of the box using foam tape

A clear plastic case houses the Raspberry Pi. WiFi and Bluetooth dongles are used to connect the Raspberry Pi to the internet and keyboard

You'll need two batteries for this build: one to power the Raspberry Pi, and another to power the display

A Bluetooth keyboard is attached (with foam tape) to the inside of the lunch box's lid. When opened up, it acts just like a regular laptop





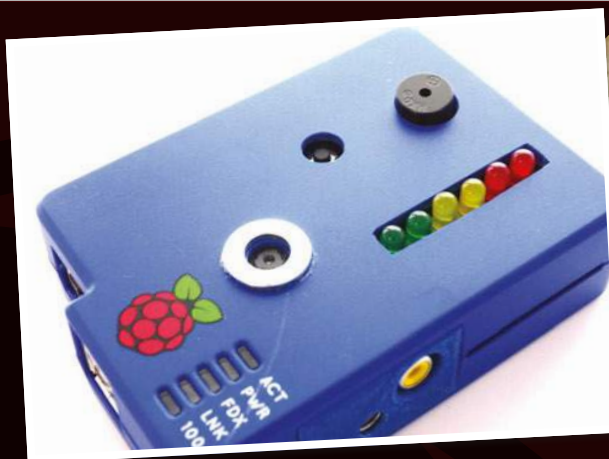

## VIDEO CAPTURE UNIT

Long-term video recording is a great idea for any spy. After all, you can't be at a stakeout all day and night. It's pretty easy to capture video on the Raspberry Pi with any webcam or the Raspberry Pi Camera Module, but we admire Matt Hawkins's Video Capture Unit ([magpi.cc/1pvwEdI](http://magpi.cc/1pvwEdI)).

This project is a simple video capture unit that records video in a loop, with the minimum amount of hardware and setting up. "I wanted a standard setup I could quickly deploy around the house, garden, car, or bike," explains Matt. "The software needed to be easy to set up so I could use it at short notice."

"It's a good first Raspberry Pi project," says D10D3, "since it requires no coding, soldering, or tooling of any kind. All you have to do is acquire the parts, plug everything in, and secure it in the lunch box.

"The Raspberry Pi isn't a very fast machine, but it's extremely versatile and easy to use. This rig will have all the functionality of a WiFi netbook, albeit a slow one, with a subtle screen."

D10D3 uses a Raspberry Pi Model B in his tutorial, but we'd advise using the newer Raspberry Pi 2 (or Pi 3) with its faster processor. Two chargers are required: an RCA for the screen, and the other for the Raspberry Pi. We'd be tempted to swap out the 5-inch display used here for a Raspberry Pi Touch Display, which connects directly to the Raspberry Pi's DSI port using a ribbon cable.

Start by charging up the batteries and installing Raspbian Jessie on the SD card. Then plug the WiFi dongle into the Pi (if not using a Pi 3) and attach the Bluetooth dongle. Connect the Raspberry Pi to the display, and attach power to the Pi and display. "Make sure everything works," advises D10D3, "You might need to configure the WiFi dongle or change the screen size. If it defaults to a resolution that's too high, it'll be hard to read the text, so you can always plug an HDMI monitor into it while you configure it."

Once you know everything works, you can use some foam tape to mount everything in the lunch box. "I only used tape on the front edge of the keyboard, so I could swing it up to turn it on and change its batteries. Make sure that you arrange things so you have room to get into it to charge stuff later. Also, make sure there's room to unplug the Pi when you're done using it, since the Pi doesn't have an on/off switch."

There are lots of ways to do a project like this, so feel free to deviate from D10D3's plans: "All of the parts are modular, and you can change its abilities by using different parts."

The Lunch Box Computer is a great project for budding spies and sleuths. It's a quick hack for hiding a Raspberry Pi, and allows you to carry your portable hacking device into places with tight security. Just be careful not to share your sandwiches, 007.

## USB DEAD DROPS

Spies need to share information – and with hackers everywhere, the time-honoured means of sharing secret documents is the 'dead drop'. This espionage trick is used to pass items between two people, without them ever having to meet each other. The USB dead drop is a modern take on the classic trick, which uses USB flash drives embedded (physically) into a wall. Greg Horton is a web developer from San Francisco, and his USB Dead Drops project ([magpi.cc/1QRSqEO](http://magpi.cc/1QRSqEO)) is an excellent primer. You'll need a USB flash drive, plumber's tape, a drill, and some patching cement. Check out Dead Drops ([deaddrops.com](http://deaddrops.com)) for further information.



## MOTION DETECTION ALARM SYSTEM



Spies don't just need to gather information – they also need to keep their location secure. When you're out in the field, what about all your files back at HQ? The answer is to create an alarm like Anne Nevin's Motion Detection Alarm System ([magpi.cc/1QJeXxf](http://magpi.cc/1QJeXxf)). We like this one because it uses Twilio ([twilio.com](http://twilio.com)) to send you alerts via SMS, so they come straight through on your mobile phone. You can set it up with any webcam, and it uses Reactive Blocks ([bitreactive.com](http://bitreactive.com)) to program the alarm system.



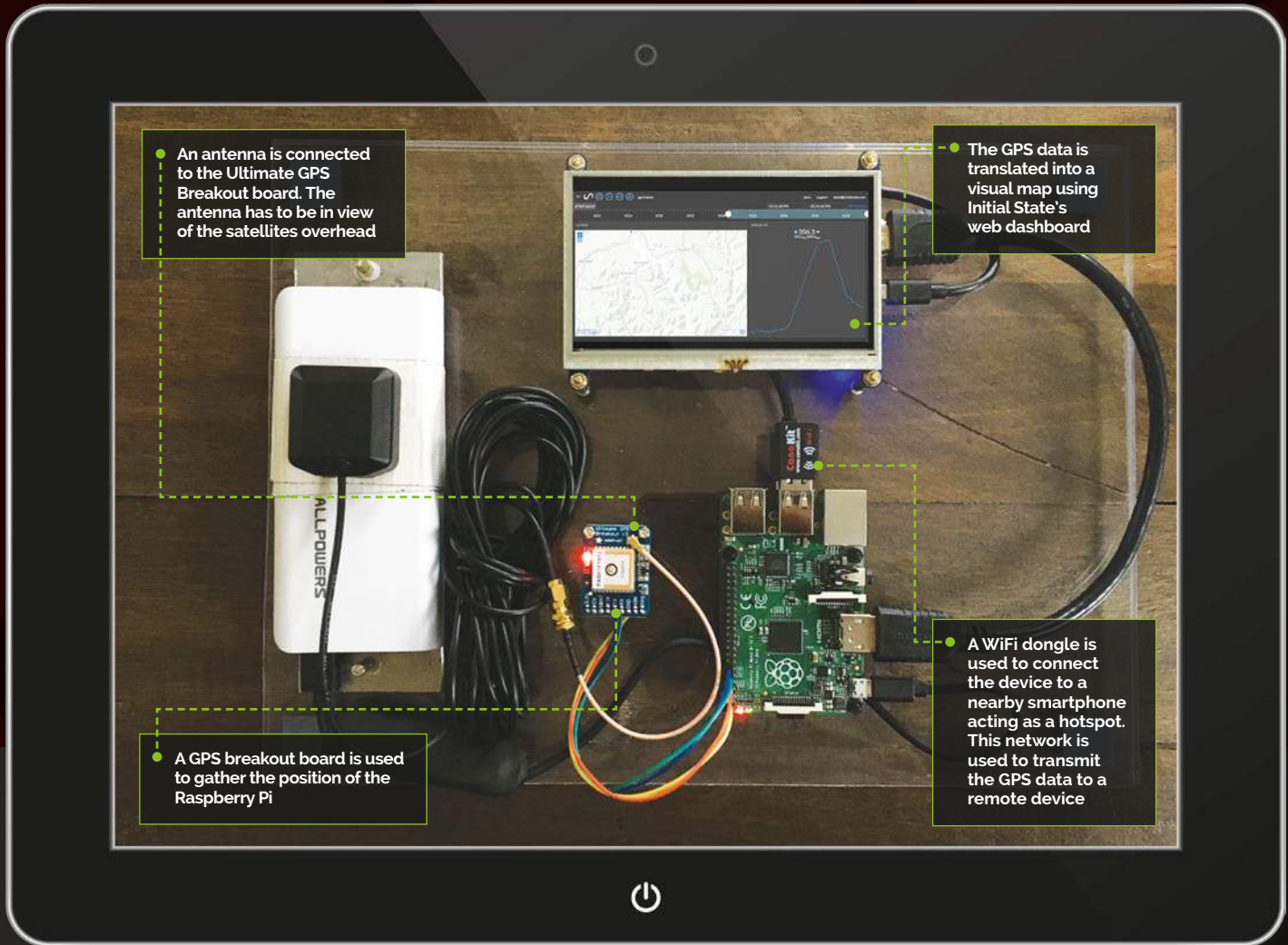

● An antenna is connected to the Ultimate GPS Breakout board. The antenna has to be in view of the satellites overhead

● The GPS data is translated into a visual map using Initial State's web dashboard

● A GPS breakout board is used to gather the position of the Raspberry Pi

● A WiFi dongle is used to connect the device to a nearby smartphone acting as a hotspot. This network is used to transmit the GPS data to a remote device

**You'll Need**

- Raspberry Pi
- Adafruit Ultimate GPS Breakout
- Battery charger
- Smartphone or WiFi hotspot device
- Adafruit SMA-to-uFL adapter
- Antenna
- WiFi dongle
- Female-to-female jumper wires

# GPS TRACKER

Keep track of movements with this hand-built GPS tracker

**T**racker devices are a classic spy staple, and building a GPS tracker from a Raspberry Pi is entirely possible – as David Sulpy, co-founder and CTO of Initial State, shows. His GPS Tracker combines a Raspberry Pi tethered to a mobile phone with an Adafruit GPS module ([magpi.cc/1Ufpyre](http://magpi.cc/1Ufpyre)).

The combined project tracks the location of the device and streams it over the mobile data connection to you. This GPS data is parsed through Initial State ([initialstate.com](http://initialstate.com)), a data visualisation web dashboard enabling you to view the GPS Tracker's location in a real-time map view.

"I researched many ways to accomplish this task without having to utilise superfluous hardware," says David. "The Raspberry Pi's proliferation as a mobile computing platform makes it the perfect candidate for projects like this."

This GPS Tracker is a project for a future member of Q Branch to get their teeth into. It combines a variety of quirky parts with a lot of interesting code, and gathers a lot of data.

The Adafruit Ultimate GPS Breakout board comes with the board, some header pins, and a CR1220

## [MAKER PROFILE]

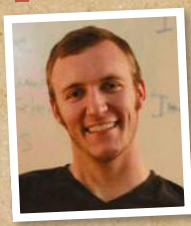

### DAVID SULPY

David is a computer scientist, software and security engineer, and founder/CTO of [initialstate.com](http://initialstate.com), a data analytics service for Internet of Things devices. [thegoodbits.sulpy.com](http://thegoodbits.sulpy.com)



## JAMES BOND HARD DRIVE

No spy is complete without a theme tune, and James Bond has the best theme tune of them all. But who wants to hear it played out of ordinary speakers, when you can get eight old floppy drives and belt it out using a Raspberry Pi to control them? That's right - old floppy drives have been hacked into musical instruments!

Daniel Kukiela's James Bond Theme On Eight Floppy Drives ([youtu.be/P3jOitAgcCI](https://youtu.be/P3jOitAgcCI)) does what it says. "I used the Raspberry Pi and proprietary software," explains Daniel. "This makes it possible to move the head with a specific frequency, thus issuing the correct head sounds. Properly selected frequencies make it possible to 'play' music on diskettes." You'll find more information (in Polish) on [PCCode \(pccode.pl\)](http://PCCode(pccode.pl)).

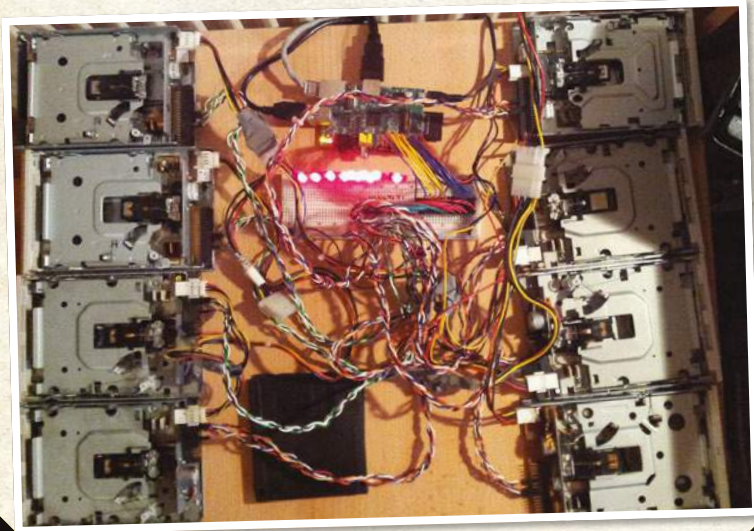

## RASPBERRY PI GEIGER COUNTER

Radiation is deadly, and all spies should be able to get out of a dangerous spot in a hurry. That's why we think Cooking Hacks' Radiation Sensor Board for Arduino and Raspberry Pi ([magpi.cc/1Ufr7oU](https://magpi.cc/1Ufr7oU)) is a great piece of kit. The board is connected to a Raspberry Pi using an Arduino Shield Connection Bridge. The device uses a J305 Geiger tube, along with a piezo speaker and LED display, to provide information on radiation levels. It can detect alpha, beta, and gamma radiation levels, as well as background radiation. Geiger tubes measure the number of pulses generated, and you'll need to convert them into sieverts to obtain workable readings. This project is an excellent learning programme for all secret agents, and you'll get to know what levels of radiation different areas and activities have (and what safe levels are).

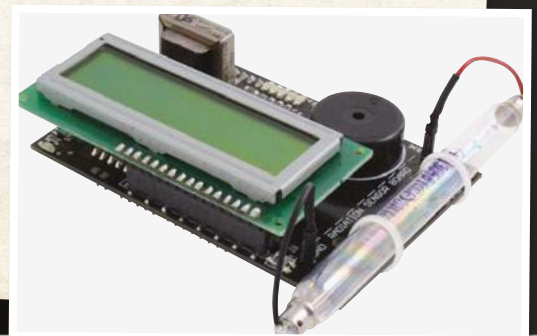

Sitting on the dashboard of a car, the GPS Tracker beams its location to a remote computer

battery holder. Wires are soldered to the board and then connected to the GPIO pins on the Raspberry Pi. "If you've never done any soldering before, I recommend you get some spare header pins, a breadboard, and a perma-proto board to practise on," says David. A uFL-to-SMA connector is then used to connect the Ultimate GPS Breakout board to an antenna.

"Make sure the antenna is placed in an area where it has a clear line of sight to some sky," advises David. "GPS requires at least three satellite fixes to triangulate a geographic position, and at least four to get an altitude."

With the GPS hardware established, you'll need to get to grips with configuring the device and testing that it works. All of the code is available on Initial State's GitHub page ([magpi.cc/1QJf4sC](https://magpi.cc/1QJf4sC)).

The project uses the pynmea2 module ([magpi.cc/1QRSy7b](https://magpi.cc/1QRSy7b)) for parsing NMEA (National Marine Electronics Association) sentences, whose output looks like this: '\$GPGGA,183345.000,3606.9007'. This obviously isn't very readable, so it's parsed through a dashboard account at Initial State ([initialstate.com](http://initialstate.com)). "We turn sensor and event data into information that matters, by making it easy to visualise and interact with data from internet-connected devices," explains the Initial State website.

"When you log into your Initial State account," says David, "you should see a 'GPS Tracker' bucket. When you select this bucket and choose the 'Tiles' application, you should see a map with the GPS coordinates."

The final part is to make the whole thing mobile, and for that you'll need a mobile phone to provide a WiFi hotspot. You can create WiFi hotspots with most smartphones, including iPhone and Android devices. The Raspberry Pi is powered by a battery and connected to the smartphone via a WiFi dongle. The result is a clever project that broadcasts its position, no matter where it goes.

# FREQUENTLY ASKED QUESTIONS

## NEED A PROBLEM SOLVED?

Email [magpi@raspberrypi.org](mailto:magpi@raspberrypi.org) or  
find us on [raspberrypi.org/forums](http://raspberrypi.org/forums)  
to feature in a future issue.

Your technical hardware and software problems solved...

## RASPBERRY PI 3

### WHAT DO I NEED TO DO TO UPGRADE AN SD CARD?

#### Raspbian Jessie

Raspbian Jessie is the preferred operating system for the Raspberry Pi 3, so if you have a relatively recent SD card written from that, you can get it ready for the Pi 3 by updating it in the terminal with `sudo apt-get update` and then `sudo apt-get dist-upgrade`.

#### Raspbian Wheezy

It's entirely possible you're still using an older SD card for this, and we completely understand why. You'll need to write a new SD card with Jessie on it from [raspberrypi.org/downloads](http://raspberrypi.org/downloads), though, to make sure it works properly on Pi 3.

#### Adding Bluetooth

The final step to make sure your SD card is ready is to install the Bluetooth drivers. Open a terminal and type: `sudo apt-get install pi-bluetooth`. For a guide on how to connect to Bluetooth devices, check our Bluetooth audio tutorial in this issue.

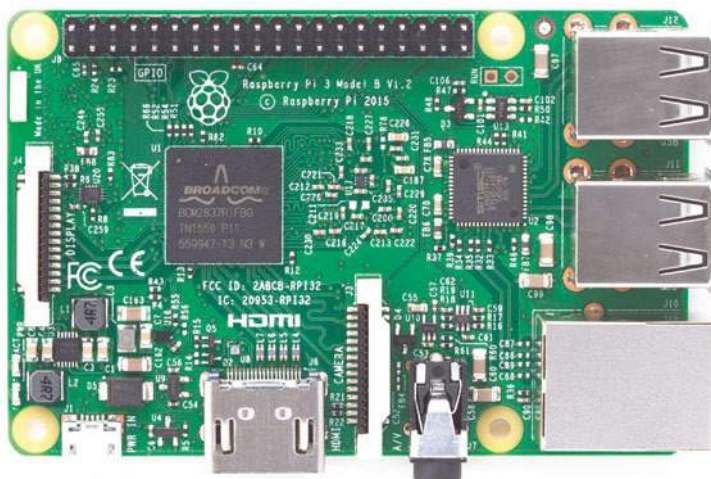

### WHAT ARE THE PHYSICAL DIFFERENCES ON THE BOARD?

#### Radio chip

Under the Pi 3 board (or at least on the side with the SD card slot on), there's a new, very small silver chip that contains the radio – i.e. the wireless LAN and the Bluetooth. It's very shiny and situated right next to the SD card slot.

#### Antenna

The antenna for the wireless LAN is on the top side of the board, next to the GPIO pins. It's right above where it says 'Made in the UK', on the opposite side to the USB ports. Don't cover it with aluminium foil!

#### LEDs

A very minor change you may not have noticed is that the LEDs have moved from where the antenna is to the opposite side, right next to the power port. You'll notice this more if you put a Pi 3 into an old official Pi case.

### HOW CAN I PORT PROJECTS TO THE PI 3?

#### Physical

The GPIO ports and all other standard ports on the Pi 3 are the same as the Pi 2, so moving over the physical side of the project should be just a case of setting it up the same way as it was before on the old Raspberry Pi.

#### Swapped SD card

If you can do the dist-upgrade on Jessie, as mentioned previously, you should be able to simply put the SD card from your other Pi straight into the Pi 3. Double-check everything works before displaying it, though!

#### New SD card

If you have a new card, you'll have to transfer files over from the old one, either via a PC and a card reader or transferring with USB storage. Once that's done, install all your necessary software and you'll be up and running again.



# FROM THE RASPBERRY PI FAQ RASPBERRYPI.ORG/HELP

## Where can I buy a Raspberry Pi?

You can buy a Raspberry Pi via our website ([raspberrypi.org/products](http://raspberrypi.org/products)), from either of our main distributors: Premier Farnell/Element14 and RS Components/Allied Electronics. These distributors sell all over the world. There are also many resellers of Raspberry Pis, both online and in bricks-and-mortar stores.

## Is there a buy-one-give-one programme for the Raspberry Pi?

Not at the current time. We may implement a programme of this sort one day, but we've come to appreciate that the scale of a programme like this may be something our small team isn't equipped to handle without taking on extra staff. You can, of course, just buy an extra Pi to donate to the person or organisation of your choice.

## What do I get when I buy a Raspberry Pi?

You get the Raspberry Pi board itself. A power supply and SD card are not included, but can be purchased at the same time from most places that sell the Raspberry Pi. You can also purchase pre-loaded SD cards too; we recommend buying these from us or our licensed distributors rather than from third parties on eBay; our software is being updated all the time and cards sold by third parties can quickly become outdated.

## How much does the Raspberry Pi cost?

The Model A+ costs \$20, the Model B+ costs \$25, the Pi 2 costs \$35, the Pi 3 costs \$35, and the Pi Zero costs \$5, plus local taxes and shipping/handling fees.

## Is the Raspberry Pi available internationally?

Yes.

## THE MAGPI APP

Having trouble with *The MagPi* on the App Store or Google Play? Here are your most common questions answered:

### How do I find *The MagPi* on Google Play or the App Store?

All you have to do is go to the search bar and type 'The MagPi' or 'Raspberry Pi' to find us.

### I've subscribed to the digital edition and I can't sign in to restore my purchases. Please help!

Since your *The MagPi* purchases are linked to your Google or Apple accounts, there's no need to sign in at all. If you'd like to re-download your purchases on your current device, or make your purchases available on other devices, all you need to do is press 'Subscribe' on the home screen, then 'Restore Purchases' on the next screen.

### How can I search the digital magazine for keywords?

Finding direct references is really easy with *The MagPi* app: all you have to do is tap the screen to get the app's GUI to show, and then press the small magnifying glass icon in the top-right corner of the screen. Just type in your search term to find the relevant results.



Maker Says

There is a thriving community building up around the ESP8266 platform Pimoroni

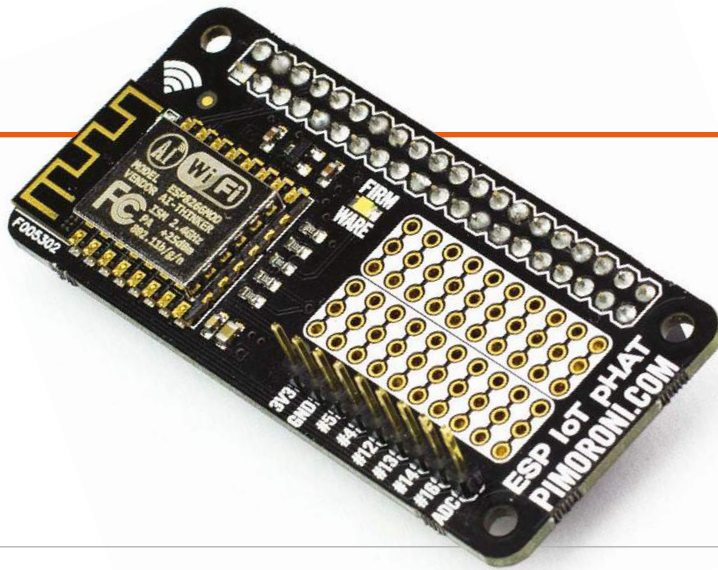

PIMORONI ESP8266 IOT PHAT

Add a low-cost WiFi HAT to your Raspberry Pi Zero and take control of wireless IoT devices

Related

ADAFRUIT HUZZAH ESP8266 BREAKOUT

Adafruit's Huzzah adds the ESP8266 chip to a breadboard-friendly breakout board. While it's not an integrated HAT-like unit, it's easier than working with just the microcontroller.

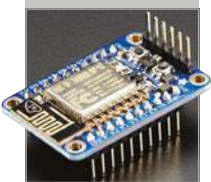

£7 / \$10

magpi.cc/21ZVV19

The addition of wireless and Bluetooth to the Raspberry Pi 3 has piqued our interest in IoT devices, but what about the Pi Zero? The smallest board in the Raspberry Pi range is ideal for low-cost IoT builds, but it doesn't feature built-in wireless.

While it's tempting to think of the ESP8266 IOT pHAT as WiFi for your Raspberry Pi Zero, this is a mistake, or at the very least an understatement. Sure, it can add WiFi to your Pi Zero, but if all you want to do is head online, you're much better off using a USB WiFi dongle.

The ESP8266 IOT pHAT is a way to get started with ESP8266, an extremely low-cost WiFi chip with a full TCP/IP stack and SoC (system on chip). ESP8266 was created by Chinese-based Espressif Systems, and hackers quickly realised it would be incredibly useful (and cheap) for building IoT devices. Hackaday's Richard Baguley explains: "[It] can connect

to 802.11b/g/n networks on the 2.4GHz band. It can be addressed with SPI or a serial connection, and has an AT command set that makes it behave rather like an old-style modem. It has everything you would need to connect a device to a WiFi network."

A wireless Zero

The chip itself came out in late 2014 and, during 2015, Western IoT enthusiasts translated its datasheets into English. Pimoroni has taken the ESP8266 and turned it into a HAT-like board, enabling you to combine the processing power of the Raspberry Pi with the wireless capabilities of the ESP8266.

Setup is moderately complex, and you'll need to solder the pins to the board. If you haven't done so already, you'll also need to solder the GPIO header to the Raspberry Pi Zero. Both are quite fiddly tasks, although we found soldering the pHAT easier than

the Pi Zero. But it's still a job for confident solderers.

Once you've soldered the board, you'll need to install Minicom (magpi.cc/1RcdWOp), a text-based communications program similar to MS-DOS Telix. Raspberry Pi enthusiast Richard Hayler has created a superb guide (richardhayler.blogspot.co.uk).

The community has done a fabulous job of translating the ESP8266 dataset from Chinese, but it's still a complex and niche area. IoT enthusiasts should certainly take a closer look.

Last word

The ESP8266 is an attractive chip, and the combination of robust TCP/IP communication and Raspberry Pi power is a compelling one. One for serious IoT project makers.





# MONK MAKES

Books & Other Bright Ideas from Simon Monk



## Electronics Starter Kit for Raspberry Pi

This kit contains everything you need (apart from a Raspberry Pi) to create ten electronic projects.

£15 / \$25

- 10 easy to follow project cards
- Quality 400 tie-point breadboard
- 20 jumper wires
- All Python code in one easy download
- Compatible with Pi B, B+, A+, Pi 2
- Includes RGB LED, red LEDs, switches, buzzer, light sensor, temperature sensor, and capacitor
- No soldering required

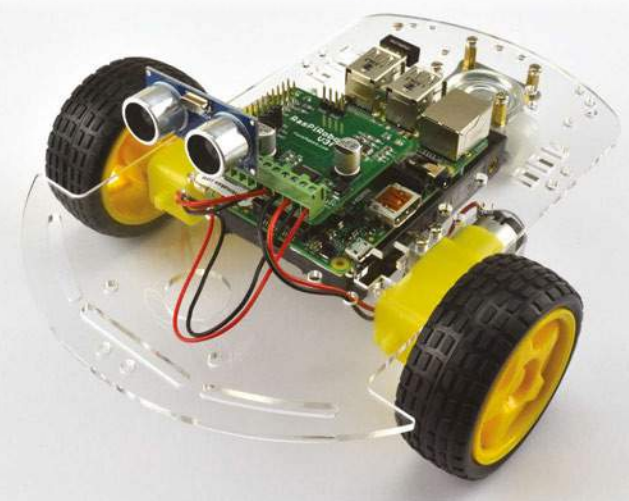

## RasPiRobot Board v3

A simple to use motor controller for the Raspberry Pi. This board is designed to simplify the process of making small roving robots and controlling medium power loads using a Raspberry Pi.

£17.50 / \$25 - \$29.95

- Dual bi-directional motor control using TB6612FNG dual H-bridge
- Dual open drain 2A MOSFET outputs
- Socket for HC-SR04 Rangefinder
- Socket for 5V I2C Interface
- Provides regulated power to Raspberry Pi
- 2 x user controllable LEDs
- 2 x header pins for switches
- Reverse polarity protection
- Open Source Python Software library
- Screw terminals for motor and power connections
- Compatible with Pi, B+, A+, Pi2

**Please note:** Illustration of possible use only, chassis, Raspberry Pi, motors, rangefinder etc. not included

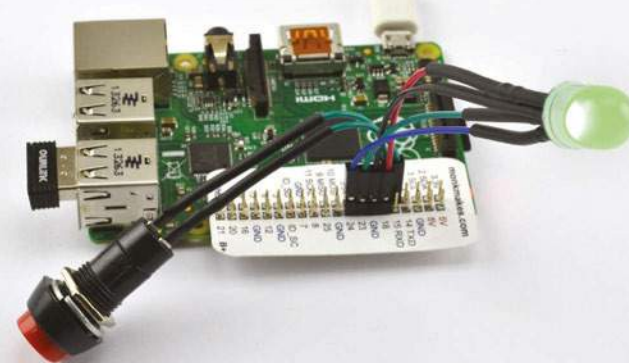

## Raspberry Squid Combo Pack

Using the included Raspberry Leaf GPIO template, attach an RGB LED and push buttons directly to the GPIO pins of a Raspberry Pi. The switches are panel-mountable and perfect when putting your Raspberry Pi project into an enclosure.

£9.65 / \$14.95

- Includes one RGB LED Squid and two Squid Buttons and a Raspberry Leaf GPIO template
- RGB LED and switches plug directly into Raspberry Pi GPIO pins
- Simple to use Python library for RGB LED control and switch debouncing

GET A 10%  
DISCOUNT

when you buy through  
**amazon.com** or **amazon.co.uk**

Enter promo code: **MAGPINOW**

[www.monkmakes.com](http://www.monkmakes.com) | [twitter@monkmakes](https://twitter.com/monkmakes)

Maker Says

Our build already works on both the RPi 2 and the RPi 3 haggster



# CHROMIUMRPI 0.4.1 (DEV BUILD)

Google’s Chrome-based operating system is being ported to the Raspberry Pi. How good is the current developer build?

One of the news stories we have this issue is about the OpenGL driver making its way into Raspbian, but it’s been available to people in general for a while now. One of the things that the OpenGL driver allows for is more software and operating systems to eventually arrive on the Raspberry Pi, so it wasn’t surprising that the ChromiumRPI project was started up to port Chromium OS over to the Raspberry Pi.

We’ve been following the ChromiumRPI project with some interest for a while now, as Chromium OS is an intriguing and lightweight OS. For those not in the know, Chrome OS is the closest thing Google has to a desktop operating system. It runs on the firm’s Chromebooks and other computers, and is based

almost entirely around Google’s Chrome browser. Chromebooks and other PCs (sometimes known as ‘Chrometops’) boot into a very basic desktop that lets you browse the web and use all your Chrome apps and settings. There’s a slightly different settings menu and a basic file explorer, but that’s your lot. Why Chromium OS, then, and not Chrome OS? Well, Chromium is the (sort of) open-source version of the browser that’s then turned into the slightly more proprietary Chrome. The same thing happens with Chromium OS and Chrome OS, which is why Chromium OS is the one coming to Raspberry Pi.

### For developers

Currently, the project is still very much in development – at the time of writing, there’s no support

for any WiFi dongles or even the wireless LAN on the Raspberry Pi 3. The 0.4.1 release did only come out a day or two after the Pi 3 was released, though, so they can be forgiven for that. However, it does mean that you currently need a wired internet connection to use it; in fact, you won’t be able to even set it up without an internet connection.

The setup is quick and simple, using the standard and very fast method in Chromium OS – all you need to do is log in with your Google account. Once that’s done, it downloads all your settings and Chrome apps that you’ve allowed to sync.

On first boot, which takes noticeably longer, you’ll probably be ready to start using ChromiumRPI within a couple of minutes. Each boot after setup is a

Related

RASPBIAN

The official Raspberry Pi operating system may not offer such an excellent way to experience the web, but it works well.

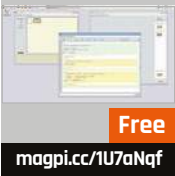

Free

magpi.cc/1U7aNaq



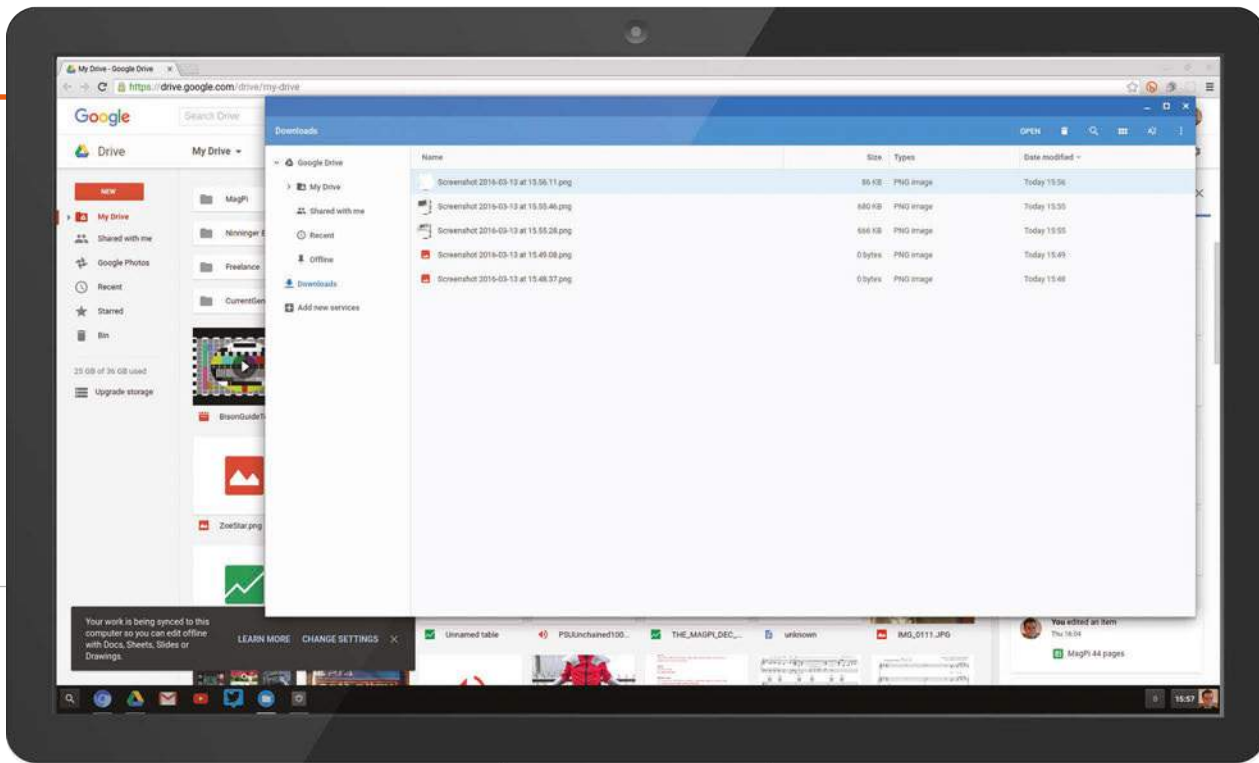

**Above** A limited file manager connects to Google Drive

lot faster on both the Pi 2 and the Pi 3, with the Pi 3 just edging out the Pi 2 in boot time.

### Get started

Once you're set up, booted up, and ready to go, you're in full Chromium OS. It's exactly the same experience as you'd get with a normal Chrome OS product. At least, most of the time: this is a development build, after all. On both the Pi 2 and the Pi 3, the OS has a habit of slowing down or even completely seizing up during use. It's a lot more noticeable on the Pi 2, which leads us to believe the extra power supplied by the Pi 3 helps out here.

The trick seems to be that you need to perform one task at a time on ChromiumRPI and give it a moment to make sure it's completed most of or all of

a task before carrying on using it. This makes it slightly slower than Raspbian to use in general, although arguably you can do more online with it.

It's a shame because except for some performance issues, ChromiumRPI is looking excellent. YouTube videos play out of the box, connections to Google Drive work fine, and even third-party apps seem to operate OK.

It's important to note that the ChromiumRPI OS isn't ready for general use – it isn't intended to be yet – but the pure potential of it is astonishing. It's already in a surprisingly pretty good state for a prototype; there's still a lot of work left for the project developers to do, but it will be a fantastic addition to the Raspberry Pi's selection of operating systems when it's done.



**Above** YouTube is supported out of the box

### Last word

It's not quite there yet, but it will be fantastic when it's done. All the prominent features are already there – it just needs a few bugs ironed out to make it usable.



Maker Says

For anyone wanting to get the most out of their new Raspberry Pi Zero  
The Pi Hut



# THE PI HUT'S ESSENTIAL RASPBERRY PI ZERO KIT

Just got yourself a Raspberry Pi Zero? You might need a little more to get it working; is the Pi Hut's kit that little more?

While it may since have been overshadowed by the arrival of a new big brother with even more power, the Pi Zero is still an excellent little computer with a tiny footprint. After getting one, though, you may need a few other bits and pieces to get it connected up, most notably USB and HDMI adapters, although there's much more you could feasibly add to it.

Since launch, there have been a few starter kits to get you going. Most of them seem to come with the USB and HDMI adapters, along with a set of GPIO pins to solder to the board – a decent set of basics. The Pi Hut's Essential Kit, though, offers a little more over these barebones kits – namely, it comes with a broad variety of different GPIO pins that you can add to your

Pi Zero. As well as the standard 40-pin set that will make your GPIO ports into something like a normal Raspberry Pi's, you get an excellent right-angle pin set and two 20-pin strips so you can just solder one side of pins. This offers a lot more options for using the Pi Zero, especially in specific projects where space is tight. With right-angled pins, you can keep circuitry relatively low; with a single line, you could also solder some wires directly to other pins. There's even a GPIO pin set of female headers much like a breadboard – this can allow for even faster prototyping.

The micro USB and mini HDMI adapters are both pretty solid – the USB adapter uses a cable rather than a fixed brick, whereas the HDMI is of the brick variety, with no cables between mini-

and normal-sized HDMI. Little rubber feet are also included in the pack, which are quite cute but largely pointless unless you plan to use the tin it comes in to store and use your Pi; it's exactly the right size for the Pi Zero, so you can keep it in there with its soft padding when not in use.

All in all, this is an excellent little kit for anyone starting out with a Zero.

Last word

A great little kit with a bit more than the bare essentials, while still selling for a great price. Also, the tin can be used as a nice little Pi Zero case if you haven't got one yet.



Related

RASPBERRY PI ZERO ADAPTER KIT

A bit cheaper and a bit more basic than the essential kit – it does come with GPIO pins, though.



£5 / \$7

magpi.cc/1Q1qsD3



[magpi.cc/1XuzXNf](http://magpi.cc/1XuzXNf)

£10 / \$15

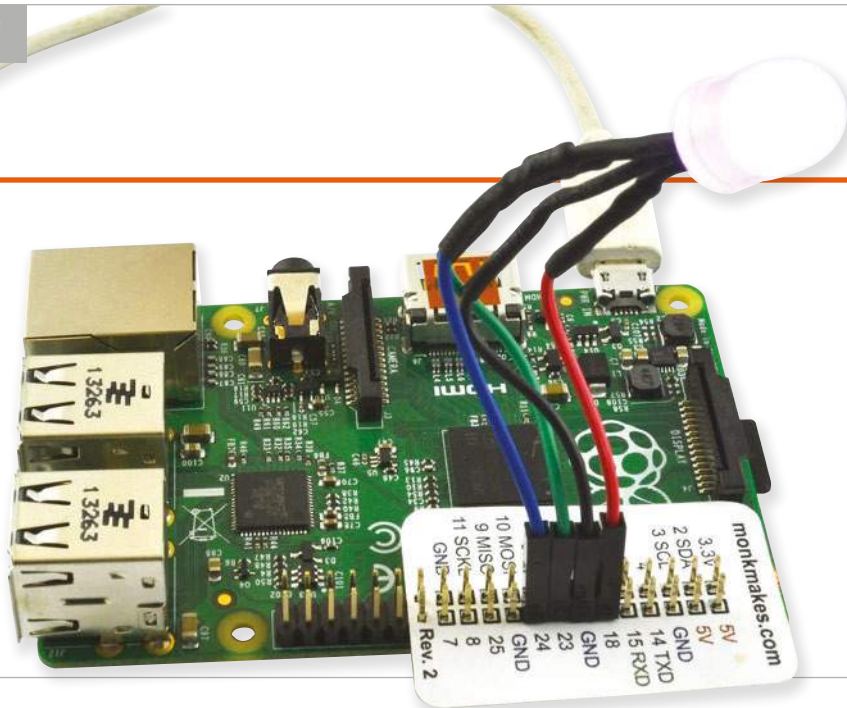

## Maker Says

A bright RGB LED with built-in resistors  
Monk Makes

# RASPBERRY SQUID COMBO PACK

An RGB LED that makes learning code quick and fun, while also being useful for other projects

One of the first things people usually do with physical computing is work out how to light an LED. A pinout, a resistor, and a ground pin are all you need to get it to work on a Raspberry Pi – and the coding can be done in many ways, depending on what language you're using. The Raspberry Squid Combo Pack takes this concept and allows you to go even further with it by adding buttons and an RGB element to the LED.

The Squid makes everything very easy to get started with; it comes pre-made so that the relevant resistors are in place and it has female pins so you can attach it straight to the Raspberry Pi. There's even a handy overlay for the GPIO so you know where everything is supposed to go.

There are many coding examples available for the LED which rely on a central squid.py library – this acts a lot like GPIO in that you just need to tell it what you want the LED to do, without too much setting up of the GPIO pins in Python. There are many examples to go through and learn from; with a little bit of poking around in squid.py (and even in GPIO Zero), you can figure out how to use it a little more manually.

There are also a couple of chunky red push buttons that come with the full combo pack, so that you can add interaction to scripts. There are some example programs and a library for them as well, which just use the button on their own; however, it should be pretty easy to figure out how

to get everything working together to create your own cool little displays. Even when you're done with the original learning side of the components, they'll be good for other projects and can easily be repurposed.

The Squid Combo Pack is a great little kit that, while maybe a touch steep price-wise, features some great components and tools that will be useful for years to come.

## Related

### NEOPIXEL RING

Available in many different sizes and prices, albeit with no buttons, but still great LEDs for projects.



£9 / \$10

[magpi.cc/1XuAvmk](http://magpi.cc/1XuAvmk)

## Last word

A great beginner's set for learning physical computing that can easily be used for any other projects you might have in the future.



# RASPBERRY PI BESTSELLERS SCALA

Not just “a better Java”, but an expressive functional programming language for the JVM.

## FUNCTIONAL PROGRAMMING IN SCALA

**Author:** Paul Chiusano & Rúnar Bjarnason  
**Publisher:** Manning  
**Price:** £27.99  
**ISBN:** 978-1617290657  
[magpi.cc/22tPaoE](http://magpi.cc/22tPaoE)

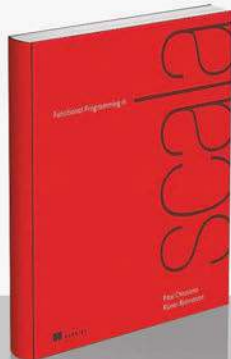

Practical, full of exercises, and an effective guide to both functional programming (FP) and Scala, for programmers with some imperative or OO experience – shines by teaching Scala as a pure FP language.

## SCALA FOR THE IMPATIENT

**Author:** Cay S Horstmann  
**Publisher:** Addison Wesley  
**Price:** £30.99  
**ISBN:** 978-0321774095  
[magpi.cc/22tPmUY](http://magpi.cc/22tPmUY)

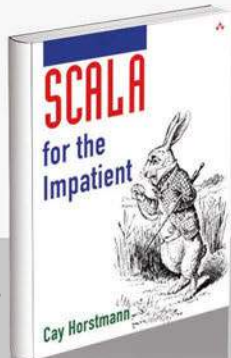

Does what it says on the tin: quick introduction to Scala with both FP and OO programming paradigms, engagingly delivering patterns and methods in ‘blog-sized’ chunks, with follow-on exercises.

## SCALA BY EXAMPLE

**Authors:** Martin Odersky  
**Publisher:** EPFL  
**Price:** Free online PDF  
**ISBN:** N/A  
[magpi.cc/22tPvYm](http://magpi.cc/22tPvYm)



A short and informal, example-led introduction from Scala’s creator, loosely based on Abelson’s and Sussman’s legendary SICP. Dives right in with Quicksort, then grounds you with language constructs.

# RASPBERRY PI WITH JAVA

**Authors:** Stephen Chin & James Weaver  
**Publisher:** McGraw-Hill Osborne  
**Price:** £27.99  
**ISBN:** 978-0071842013  
[magpi.cc/22tPJ1G](http://magpi.cc/22tPJ1G)



This is a fun, project-oriented way of learning embedded application development through the Raspberry Pi – and the Java language. Java 8 is preloaded in Raspbian and NOOBS and, while not an ideal language for beginners – it certainly doesn’t fit the move away from boilerplate for teaching languages to young people – Java is well supported by libraries, and availability of help.

After the obligatory setup chapter, then installing the NetBeans IDE and the JDK, the authors set the reader up for developing on their own desktop

machine, then running remotely on the Pi. With HelloRaspberryPi.jar successfully executing remotely,

Chin and Weaver move onto a great collection of interesting projects. Never mind blinking an LED, here we start with connecting a USB scale for precision coffee brewing; Java GPIO libraries are introduced to make a binary countdown clock; then we move on to magic – a top hat that can guess a card value (by cheating, but it’s all part of the fun). By chapter 5 we’re using Makeblock components to make a line-following robot; then we revisit our coffee project to improve accuracy – and make tea. Autonomous drones and retro gaming round off a cornucopia of hardware projects. Who knew Java could be such fun?

Score ★★★★★

# PRACTICAL LINUX TOPICS

**Author:** Chris Binnie  
**Publisher:** Apress  
**Price:** £33.99  
**ISBN:** 978-1484217719  
[magpi.cc/22tQkAF](http://magpi.cc/22tQkAF)



There’s a lot going on beneath the surface of an operating system that can also be found running on most of the world’s top supercomputers. From startup scripts to network troubleshooting, there are tools and techniques to help keep your Pi, or your supercomputer cluster, running smoothly. Binnie delves deeply into more than a dozen problem areas, helping you to get the most from some very powerful command-line tools.

*Practical Linux Topics* is aimed at sysadmins, and those drawn into sysadmin tasks through DevOps, but contains plenty that regular

GNU/Linux users could benefit from. The Unix principal of tools that ‘do just one thing, but do it well’ means that short chapters focus on single problem areas, making great references. The first chapter shows the best way to run netstat to find network problems, then shows why iftop is almost always better;

the systemd chapter is for everyone still catching up with the generational change to Linux startup; everything from SSH security to managing disks gets a useful, detailed examination; humble tools like wget are dusted off and shown in all their flexible utility. Add in live kernel patching, GPG, and sudo, and you can see this slim volume packs plenty of useful admin know-how.

Score ★★★★★



## PRACTICAL MACHINE LEARNING

**Author:** Sunila Gollapudi  
**Publisher:** Packt  
**Price:** £29.99  
**ISBN:** 978-1784399689  
[magpi.cc/1MzMNnL](http://magpi.cc/1MzMNnL)

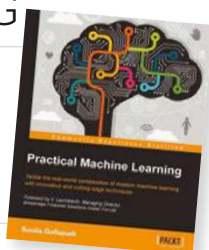

Machine learning sits at the heart of tackling big data problems, and Gollapudi's far-reaching work is framed by a whole ecosystem of machine learning and big data tools. Using a stack of R, Apache Mahout, Python scikit-learn, Julia, and Apache Spark, she takes the programmer through all of the tools needed to attack real problems from a number of angles.

Starting with the fundamentals of machine learning and predictive analysis, the author drills down through definitions of machine learning to arrive at the fundamental "mechanism for pattern search" that underlies

"how machines perceive the environment." Training datasets and performance measures lay the groundwork for datasets, and some machine learning challenges.

You'll need a little Python or R to keep your head above water here, but will also be introduced to the fascinating Julia language – becoming very popular with data scientists. Several components of the Hadoop ecosystem, including Apache Mahout and Spark libraries, round out our toolkit. These introduced, we move through decision trees; instance and kernel based learning methods; association rules; clustering methods; Bayesian learning; regression analysis; neural networks; reinforcement learning; and ensemble methods. An impressive set of tutorials, complemented by plenty of downloadable code examples.

Score ★★★★★

## HELLO RASPBERRY PI!

**Author:** Ryan Heitz  
**Publisher:** Manning  
**Price:** £15.99  
**ISBN:** 978-1617292453  
[magpi.cc/1MzNcGE](http://magpi.cc/1MzNcGE)

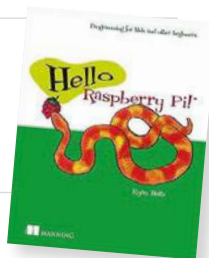

The book's subtitle is 'Python programming for kids and other beginners', and Heitz manages that rare trick of assuming the audience knows little of the subject, but never talking down to them, which – combined with gentle humour and occasional silliness – keeps the reader engaged with Python through learning several concepts and techniques. With its regular boxes explaining computer terms, clearly annotated code listings, and good introductions to hardware components and their use, *Hello Raspberry Pi* is a model introduction for learners of any age.

The setup section manages to introduce several programming concepts, and some gratuitous *Monty Python* references – so far, so good. The middle section uses games to teach Python programming: a silly sentence generator introduces string methods, and, as with every chapter, carefully chosen challenges push the reader further. The Norwegian Blue parrot game introduces if and while, thinking about program logic, and the wonders of ASCII art. Then Raspi's Cave Adventure shows how to build on this to make a larger program.

Part 3 brings in hardware fun, calling external programs, and ways with lists. Appendices cover troubleshooting, older boards, challenge answers, and further projects to try. A firm foundation for any Python learner.

Score ★★★★★

## ESSENTIAL READING: JAVASCRIPT FRAMEWORK ESSENTIALS

Learn the essential framework choices for your project amongst the many competing JavaScript offerings

### JavaScript Frameworks for Modern Web Dev

**Author:** Tim Ambler & Nicholas Cloud  
**Publisher:** Apress  
**Price:** £32.50  
**ISBN:** 978-1484206638  
[magpi.cc/1MzNw8d](http://magpi.cc/1MzNw8d)



A practical guide for the perplexed, ably covering the essentials at both ends of the development stack (browser and server).

### Mastering Backbone.js

**Author:** Abiee Echamea  
**Publisher:** Packt  
**Price:** £31.99  
**ISBN:** 978-1783288496  
[magpi.cc/1MzNSfc](http://magpi.cc/1MzNSfc)



Go beyond Backbone.js basics, with well-structured and scalable web apps, plus deployment, and automated testing.

### Getting MEAN with Mongo, Express, Angular, and Node

**Author:** Simon Holmes  
**Publisher:** Manning  
**Price:** £27.99  
**ISBN:** 978-1617292033  
[magpi.cc/1MzNAF4](http://magpi.cc/1MzNAF4)

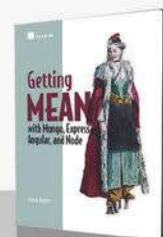

Thoughtful exploration of the MEAN stack, building on static pages, then re-factoring as Single Page Apps.

### Getting Started with Meteor.js JavaScript Framework

**Author:** Isaac Strack  
**Publisher:** Packt  
**Price:** £17.99  
**ISBN:** 978-1785285547  
[magpi.cc/1MzNl0a](http://magpi.cc/1MzNl0a)

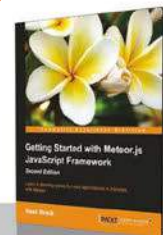

Strack gets you marvelling at Meteor's abilities, as well as explaining how it works, and integrating other front-end clients.

### Learning React Native: Building Native Mobile Apps with JavaScript

**Author:** Bonnie Eisenman  
**Publisher:** O'Reilly  
**Price:** £26.50  
**ISBN:** 978-1491929001  
[magpi.cc/1MzNL3d](http://magpi.cc/1MzNL3d)

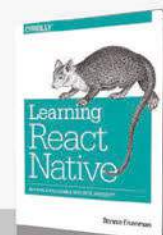

Turns your React knowledge into native apps for iOS and Android, keeping existing tools and workflow.

# THE MONTH IN RASPBERRY PI

Everything else that happened this month in the world of Raspberry Pi

## RASPBERRY PIS BOLDLY GO

**L**ast month, we reported on the Astro Pi case being available for 3D printing. It didn't take long for 3D printers around the world to start whirring into life as people made their very own space cases for their Raspberry Pis. Here are some of the builds we've seen over the last month.

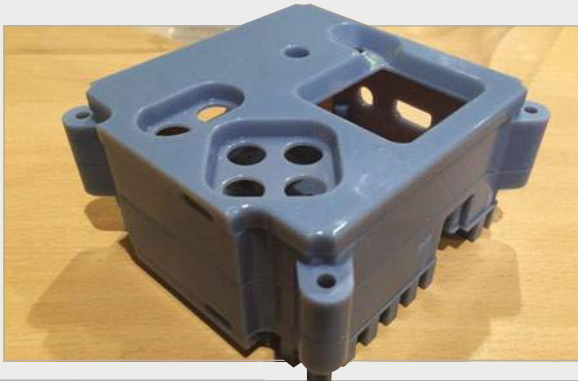

**Right** A beautiful 3D print of the Astro Pi case, sans hardware



### ASTRO PI GIVEN TO UNITED ARAB EMIRATES SPACE AGENCY

A very important 3D printed case was made by the UK Space Agency (UKSA) to present to a representative of the United Arab Emirates (UAE) Space Agency. It's been specially printed and finished to look wonderfully smooth, and it was installed with a Raspberry Pi, Sense HAT, and all the necessary buttons. The finished product can be seen in the image above being handed over by David Parker, chief executive of the UKSA, to Khalifa Mohammed Al Rumaith, chairman of the UAE Space Agency. Read all about it here: [magpi.cc/21wFRyv](http://magpi.cc/21wFRyv).



**Above** This very bright orange case from John Chinner is complete and ready to go  
**Right top** A multicoloured effort from Patrick Wiatt just needs some hardware to finish it  
**Right bottom** You won't lose these fluorescent Astro Pi cases very easily!



# CROWDFUND THIS!

The best crowdfunding hits this month for you to check out...

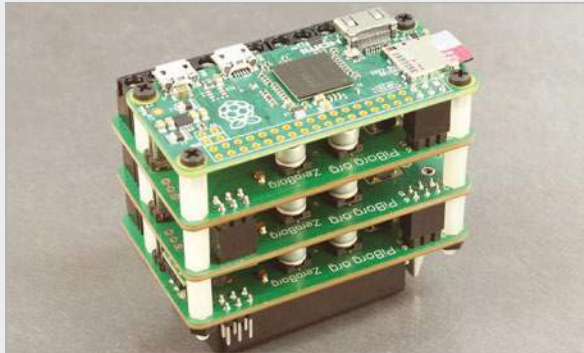

## ZEROBORG

[kck.st/1RJsQ1Y](http://kck.st/1RJsQ1Y)

The robo-experts of PiBorg are no strangers to the pages of *The MagPi*, with a few of their robots and kits featured for one reason or another. Right now, they have a new piece of kit they want to show off: the ZeroBorg. It's a brand new motor controller board with the form factor of a Raspberry Pi Zero, and it also includes some analogue inputs for sensors and such. At the time of writing, they've hit their target and if you hurry, you'll be able to take advantage of the backer rewards for it as well.

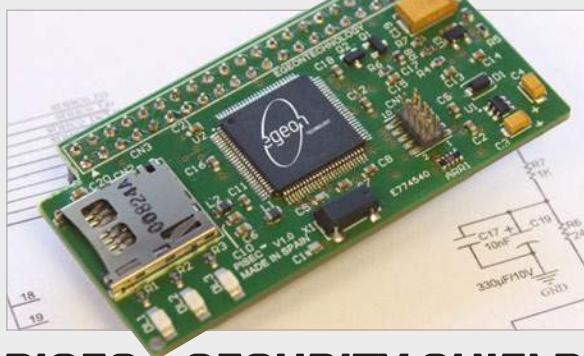

## PISEC - SECURITY SHIELD

[kck.st/1W4wGUD](http://kck.st/1W4wGUD)

"Protect your Raspberry Pi from all angles," says the Kickstarter for PiSec, an add-on board that adds an extra layer of tough hardware security to your Raspberry Pi. The developers believe this is a good deterrent if you're using it as an IoT device and want to protect your home, or if you're an industry type and want more protection on your hardware. It's still requiring funding on Kickstarter at the time of writing, though, so give it a look if you want added security for your Pi.

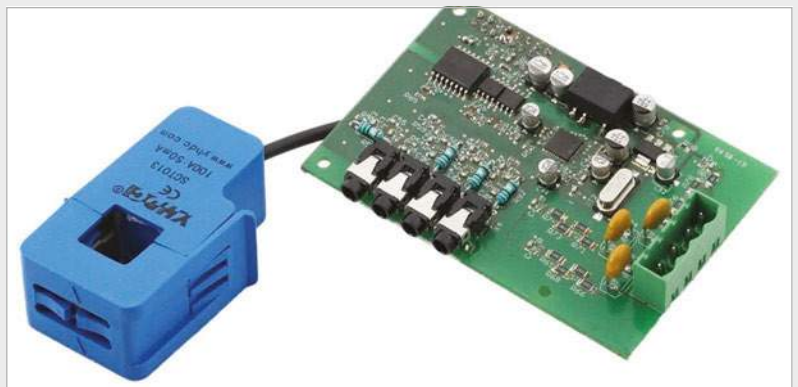

## SMARTPI

[kck.st/1Ks65Qp](http://kck.st/1Ks65Qp)

This one is a little more niche, but nevertheless an excellent use of the Raspberry Pi – the SmartPi allows you to turn a Raspberry Pi into a smart meter for electricity. It's an add-on board that measures voltage and current: "Current is measured via contactless inductive current sensors. In the standard version, currents up to 100A can be measured. By exchanging the series resistor to use other sensors, [measurement of] currents up to 300A is feasible."

## BEST OF THE REST

Here are some other great things we saw this month

### PI-SAT

[magpi.cc/21wHrR5](http://magpi.cc/21wHrR5)



Credits: NASA/Goddard/Rebecca Roth

As it was Pi Day while writing this magazine, a few tech companies did a little something to celebrate. One of the coolest things we saw was NASA's Pi-Sat, a tiny little satellite cube that's based on a Raspberry Pi. It's 3D printed and looks really quite cute.

### WD PIDRIVE

[magpi.cc/1PmqjXb](http://magpi.cc/1PmqjXb)



A 314GB USB hard drive launched on Pi Day, and with special optimisations for Raspberry Pi that means it should draw less power than other USB drives, while still operating at maximum speed. It also currently costs \$31.42 (£22), so they're going full-on with the Pi theme.

# MIND THE [SKILLS] GAP

The North West needs coders as its tech economy looks set to boom. The Digital Skills Festival looked at the short- and long-term solutions, with a little help from Code Club and Lego

## SKILLS AUDIT

You can see more of the North West's challenges in Graham Benson's presentation at [magpi.cc/1UaHHXh](http://magpi.cc/1UaHHXh)

**Below left** Six little bricks to show creativity in action

**Below right** Manchester Digital chair Graham Benson highlighted what the North West's technology companies are doing to bridge the skills gap, and where they need help

**B**ehind the hype of the 'northern powerhouse' lies a real success story for the tech industry of Manchester and the North West. New tech businesses are starting, and existing ones are growing rapidly. But success can bring new problems.

Manchester Digital, the regional trade body, took a Skills Audit for 2016 of the local tech industry. The worrying results – presented at the conference day of the 2016 Digital Skills Festival – show a shortage of people with tech skills to fill local jobs, a severe gender imbalance in the industry, and spiralling wages as a result of the shortage. None of this will be news to anyone with even half an eye on tech, but the conference was about tackling the problem at every stage, and, from Code Club to Picademy, positive solutions were presented.

The challenge that is facing Graham Benson, the new chair

of Manchester Digital (MD), is the region's acknowledged skills shortage. MD's Skills Audit revealed that two thirds of businesses had struggled to fill developer roles in the last year, 44% had had to inflate salaries to compete, and – most worrying – a third had turned down work, for lack of resources to grow to take it on. Richard Leese, leader of Manchester City Council, looked forward to "digital skills embedded across the curriculum", acknowledging that this will require teacher training and new equipment.

## Town and gown

Representatives of every stage of education were there with answers – if not always in agreement – for training the next generation. Salford University's Professor Robin Bargar outlined plans for an industry collaboration to "incubate

for the needs of *future* jobs." One local art college, looking to expand their UX course, told *The MagPi* that the real problem was getting students with the blend of art, psychology, and maths skills – a path that schools are not offering creative students. Sixteen-plus tech education is also where the gender gap in tech becomes apparent, as Loreto College computing A-level student Katie – on the 'Beyond the Curriculum' panel – told the Festival audience, as one of the only girls she knew interested in the subject.

## Mind the gender gap

With only 30% of tech roles being filled by women, and one in five local tech businesses being all-male, there's an obvious waste of potential female tech talent. Again, this isn't news, but with 'developer' reported as the hardest post to fill, it was great to hear from Manchester's many community groups involved in coder training, from Coder Dojo to Manchester Digital Laboratory (MadLab) – a grass-roots innovation organisation focused on science and technology, arts, and culture. Innovation charity NESTA's research shows only 17% of tech jobs taken by women, and a forecast one million tech jobs going unfilled by 2020: a very real economic cost to tech's sad lack of diversity. MadLab run a range of







MadLab director Rachel Turner shared what makes their community courses so successful

courses, with an even gender split among participants, and have a good track record of getting people of all backgrounds involved.

Rachel Turner, director and co-founder, proudly stated that 35% of their course participants had “got jobs or promotions as a result of their MadLab training.” MadLab’s involvement with Raspberry Pi is extensive, from the first ever

Hill University’s free computing workshops for teachers include Sonic Pi (KS2/3); Geocraft – Programming Minecraft using the Raspberry Pi (KS2/3); Logic Gates (KS3/4); and Python (KS3/4).

### Duck!

While industry figures challenged educationalists to work more closely with them, the day

## “ Innovation charity NESTA forecasts one million tech jobs going unfilled by 2020 ”

Raspberry Jam, to their work with local libraries using Pis to run training. Training enough women into the workforce is a vital task, but for long-term change, schools need to give early opportunity to all young learners.

The changes to the national curriculum, introducing coding and computational thinking, are a big help here. Code Club has been offering help to teachers, as well as primary school children, as has Picademy – offering two days’ training, and the coveted swag bag – and in Manchester, community groups like Coder Dojo have been hosting Picademy events, as Steven Flower outlined at the Festival. Further west, Edge

finished with the audience being challenged: “Make a duck,” commanded Gareth Boldsworth, director of Lego Education, handing out six Lego bricks, and the results showed just how many possibilities there were for turning blocks into birds. “Failure is an option in Lego Education,” said Boldsworth, explaining how his Lego division is building the engineers of tomorrow. Within the EU, he said, between 8 and 22% of students go on to careers in their university discipline, and “65% of the jobs in 2020 don’t exist today.” The 21st century’s most important skills are “creativity, critical thinking, collaboration, and problem-solving.”

Growing the digital talent pool from the ground up.

## CODE CLUB, IN SPACE – AND BEYOND!

One of the (many) highlights of the Astro Pi contest was Cranmere Primary School’s Code Club entry. The ten- and eleven-year-old children, on being told that their entry would be coded up by developers at the Raspberry Pi Foundation, said a polite “no thanks: that’s what we do; we’ll do it ourselves,” and they did.

This was one of several inspiring tales that Liz Smart, North West co-ordinator for Code Club, gave the Skills Festival audience, before putting in a plea for more volunteers. We got chatting to Smart about how the Pi was helping to open up coding for young people: “We see primary school children using Pis in class and at Code Clubs, secondary school children heading to the Pi table at their local Coder Dojo, and college students attending Pi hackathons run by learning networks like Hive Manchester,” she told us. “There are now opportunities for youth of all ages to develop their skills and grow their interest in digital making; the fact that these activities are affordable, both to run and for the young people to continue at home, is key.”

She told us of a primary school in Salford, which had no computers the children could use. They were trying to set up a Code Club, with the students using the teachers’ laptops: “but the teachers would all need to stay behind, there was a risk to their files, and it just wasn’t practical.” Around the same time, MadLab opened a new co-working space in Salford and stepped in to run a club for that school, and others. “They were able to get a bunch of Raspberry Pis for the kids to use without spending too much money... Since then, the club has grown: they’ve introduced soldering (a session run by Mitch Altman of TV-B-Gone fame which the kids loved!), Codebug (run by MadLab themselves), and attended a World Scratch Day competition at the National Football Museum. The kids wouldn’t have accessed coding or experienced any of those amazing additions if there hadn’t been a low-cost computer available to start their journey.”

### CODE CLUB NEEDS YOU!

Plenty of primary schools would love to have a Code Club, but need a volunteer. Download the Scratch teaching materials and take a look: you could do that! Find out more at: [codeclub.org.uk/start-a-club/volunteers](http://codeclub.org.uk/start-a-club/volunteers).



**3** **FABLAB TACOMA RASPBERRY JAM**  
Tacoma, WA, USA

**4** **SPRING 2016 ROANOKE RASPBERRY JAM**  
Roanoke, VA, USA

# RASPBERRY JAM EVENT CALENDAR

Find out what community-organised, Raspberry Pi-themed events are happening near you...

## PUT YOUR EVENT ON THE MAP

Want to add your get-together? List it here:  
[raspberrypi.org/jam/add](http://raspberrypi.org/jam/add)

**1**

### 2ND ANNUAL HISAR CODING SUMMIT

**When:** Saturday 9 April  
**Where:** Hisar School, Istanbul, Turkey  
[event.hisarcs.com](http://event.hisarcs.com)

The goal is to share essential knowledge of programming and algorithmic thinking.

**3**

### FABLAB TACOMA RASPBERRY JAM

**When:** Sunday 10 April  
**Where:** 1938 Market Street, Tacoma, WA, USA  
[magpi.cc/1pwp10x](http://magpi.cc/1pwp10x)

A two-hour workshop (\$85) to get you started with a Raspberry Pi. You even get to go home with one.

**5**

### HULL RASPBERRY JAM

**When:** Saturday 23 April  
**Where:** Malet Lambert School, Hull, UK  
[magpi.cc/1pwqRVM](http://magpi.cc/1pwqRVM)

Explore the opportunities of the Raspberry Pi and help launch a Mars mission... sort of.

**2**

### 3RD PETERBOROUGH RASPBERRY JAM

**When:** Saturday 9 April  
**Where:** University Centre Peterborough, UK  
[magpi.cc/1RoZ715](http://magpi.cc/1RoZ715)

Offering an assortment of activities including talks, workshops, and show-and-tells.

**4**

### SPRING 2016 ROANOKE RASPBERRY JAM

**When:** Saturday 16 April  
**Where:** CoLab - Innovation Lab, Roanoke, VA, USA  
[magpi.cc/1pwpR3Z](http://magpi.cc/1pwpR3Z)

Topics will include building a robot with the Raspberry Pi and projects with the RaspberrySTEM kit.

**6**

### PLYMOUTH RASPBERRY JAM

**When:** Saturday 23 April  
**Where:** Thinqtanq, Plymouth, UK  
[magpi.cc/1R13OuV](http://magpi.cc/1R13OuV)

Either work on some supplied projects to learn about Pi, or work on your own projects and get some help.





## 6 PLYMOUTH RASPBERRY JAM

Plymouth, UK

## 1 2ND ANNUAL HISAR CODING SUMMIT

Istanbul, Turkey

## 7 EDINBURGH RASPBERRY JAM

Edinburgh, UK

## 5 HULL RASPBERRY JAM

Hull, UK

## 2 3RD PETERBOROUGH RASPBERRY JAM

Peterborough, UK

## 8 PRESTON RASPBERRY JAM

Preston, UK

## EDINBURGH RASPBERRY JAM

**When:** Saturday 30 April

**Where:** CodeBase, Edinburgh, UK  
[magpi.cc/1R17kWi](http://magpi.cc/1R17kWi)

A range of talks and project presentations in the morning, followed by a hands-on workshop session in the afternoon.

# 7

## PRESTON RASPBERRY JAM

**When:** Monday 2 May

**Where:** Media Innovation Studio, Preston, UK  
[magpi.cc/1R17rkD](http://magpi.cc/1R17rkD)

Come and learn what you can do with a Raspberry Pi computer, in an open, sharing, family-friendly environment.

# 8

# DON'T MISS: PETERBOROUGH RASPBERRY JAM

**When:** Saturday 9 April **Where:** University Centre Peterborough, Peterborough, UK

The third Peterborough Raspberry Jam will have a packed schedule, including workshops on FUZE, the Sense HAT, and the EduKit 1. There will also be talks from members of the community, along with a show-and-tell area and marketplace full of vendors of Pi-related merchandise. It should be a great day for people of all ages and skill levels. For more details, check out the event page: [magpi.cc/1R0Z715](http://magpi.cc/1R0Z715)





# Add a blueberry to your Raspberry Pi

## Turn your Raspberry Pi into a Multi-Purpose IoT Controller Board

The Blueberry IoT Controller for the Raspberry Pi is a versatile device designed to interact with the real world by reading sensors, controlling electrical equipment and using popular communication channels.

It is supported by a range of other devices which can turn your Raspberry Pi into the nerve centre of a simple or complex monitoring and control system.



## CONTROL

**gates, garage doors, air-conditioning, irrigation systems and much more.**

Use the power and connectivity of the Pi or the on-board GSM to control your system from anywhere in the world or receive reports and alerts via email or texts (SMS).



# www.rapidonline.com

Rapid Electronics part of the **CONRAD** Group



# IQaudio

Audiophile accessories for the Raspberry Pi



## Pi-DAC+

- Raspberry Pi HAT, no soldering required
- Full-HD Audio (up to 24bit/192MHz)
- Texas Instruments PCM5122
- Variable output to 2.1v RMS
- Headphone Amplifier / 3.5mm socket
- Out-of-the-box Raspbian support
- Integrated hardware volume control
- Access to Raspberry Pi GPIO
- Connect to your own Hi-Fi's line-in/aux
- Industry standard Phono (RCA) sockets
- Supports the Pi-AMP+



## Pi-AMP+

- Pi-DAC+ accessory, no soldering required
- Full-HD Audio (up to 24bit/192MHz)
- Texas Instruments TPA3118
- Up to 2x35w of stereo amplification
- Provides power to the Raspberry Pi
- Software mute on GPIO22
- Auto-Mute when using Pi-DAC+ headphones
- Input voltage 12-19v
- Supports speakers from 4-8ohm



## Pi-DigiAMP+

- Raspberry Pi HAT, no soldering required
- Full-HD Audio (up to 24bit/192MHz)
- Texas Instruments TAS5756M
- Up to 2x35w of stereo amplification
- Out-of-the-box Raspbian support
- Integrated hardware volume control
- Provides power to the Raspberry Pi
- Software mute on GPIO22
- I/O (i2c, 3v, 5v, 0v, GPIO22/23/24/25)
- Just add speakers for a complete Hi-Fi
- Input voltage 12-19v
- Supports speakers from 4-8ohm



Twitter: @IQ\_audio  
Email: info@iqaudio.com

WWW.IQAUDIO.COM

IQaudio Limited,  
Swindon, Wiltshire.  
Company No.: 9461908





# BUILD YOUR OWN MOTION-ACTIVATED SECURITY CAMERA

THE SECURITY CAMERA SOLUTION FOR THE RASPBERRY PI FROM SB COMPONENTS

**BUY YOURS NOW**  
at: [spi-box.co.uk](http://spi-box.co.uk)



**SPi-BOX** is the first Raspberry Pi case specifically designed to mount both the PIR and Raspberry Pi camera modules. The perfect solution for your PIR/camera project.

### BASE KIT INCLUDES:

- SPi-BOX case (available in white or black)
- Instructions for setting up the security kit
- GPIO connectors
- PIR module



[www.spi-box.co.uk](http://www.spi-box.co.uk)

Call **0203 514 0914**

At **SB Components** we strive to offer our customers the best prices for the best products. Our product team works tirelessly to source top quality affordable components from around the world.

Raspberry Pi is a trademark of the Raspberry Pi Foundation. Raspberry Pi not included. \*Compatible with Raspberry Pi

# STORAGE FOR PI. SPACE TO CREATE.

Introducing **WD PiDrive 314GB**

Engineered for your  DIY projects



Limited Time Promo Price

**Lower power consumption.** With custom data recording and electrical design, the WD PiDrive 314GB is engineered to draw less power for use with Raspberry Pi.

**Fully customizable.** Build storage-hungry projects to your desired needs, whether a media player, security camera or NAS. The WD PiDrive 314GB is as versatile as your Raspberry Pi.

**Free WDLabs Berryboot download for new users.** Includes additional Raspberry Pi applications just for HDD storage usage.

Learn more at [wdlabs.wd.com/magpi314](http://wdlabs.wd.com/magpi314)



# YOUR LETTERS



**Above** Buying digitally can be done anywhere in the world and doesn't have any delivery fees

## Green magazine

Firstly, let me state what a great magazine you produce; it's full of useful, well-written, informative articles.

In a world where we are all told that we need to cut our carbon emissions in order to save the planet from certain annihilation, I choose to subscribe electronically to your magazine. It is the obvious carbon-neutral choice, yet I'm left wondering why people who buy the print version get extra bonuses, when we digital subscribers are the ones saving the planet?

**Derek Hughes**

## Pay it forward

I wish to thank you for making *The MagPi* downloadable, as I now live in Costa Rica and having *The MagPi* sent here would be a total waste, if it ever got here. I am just beginning to work with a Raspberry Pi B and 3, as well as Arduino. I began my association with computers in 1960 as a guidance system tech with the Bomarc IM-99A. That was my first experience with programming on a breadboard. I have not been active much with computers in this way for many years, except for using them for day-to-day tasks. This will be a new challenge for an older fellow. It is almost like starting over, but it will be very enjoyable. Keep up the good work with *The MagPi*. I now want to find out how to make donations to *The MagPi*.

Thanks for all you do.  
**Arthur Sulenski**

Hi Arthur. Thanks for getting in touch. We're very pleased you're enjoying the PDFs of the magazine! In terms of donating, it doesn't quite work like that, as all our profits go to the Raspberry Pi Foundation to fund their charitable mission anyway. If you wish to do this through us, the main way is by buying our issues from our app on your tablet or smartphone. That way, there's no extra cost for shipping to Costa Rica, you get a better reading experience, and we can send our profits straight up the ladder to the Foundation.

We see where you're coming from, Derek. However, we'd like to state for the record that the printed magazine itself is extremely green. We make it a point to only use paper from sustainable forests, and the printers that actually make the magazine operate with environmental management systems conforming to ISO 14001. The magazine itself is also completely recyclable!

Unfortunately, due to the limited number of Raspberry Pi Zeros at launch, we had to attach them to a finite supply of physical magazines. It's also very difficult to attach a physical computer to a digital product - logistically it would've been impossible.





## Future giveaways

So, with issue 40 you gave away Raspberry Pi Zeros and with issue 43 you gave away the codes to get Raspberry Pi 3 a bit earlier. It's making me consider becoming a subscriber in case I miss any of these!

Do you plan to continue doing giveaways in some form in the future? Is there a specific subscription level we need for this? Any clues on what the next one will be?

Thanks!  
Kim

We definitely plan to do more giveaways over time, but we couldn't possibly tell you what they are. That would ruin the surprise.

As for subscriptions, any print subscription will net you any bonuses we offer, and sometimes you'll get it a bit early as well. Three-, six- and twelve-month subscription plans all get the same stuff if we end up giving it away with an issue, and you can have a look at starting a new sub on pages 34 and 35 or via [magpi.cc/Subs1](http://magpi.cc/Subs1).

## Worldwide MagPi

I was excited to see that you've now printed out the Essentials e-books as actual real books. However, as I live in the US, I was wondering how long I was going to have to wait until it shows up in my local Barnes & Noble. It's normally a month or so, but I was wondering if there was a way I could get them right now?

Bill C

Currently, we don't actually have anywhere lined up that will stock them physically - we're only selling them online. The good news about that, though, is that our new store delivers to America and many other places around the world. You can get to the store here: [magpi.cc/MagPiStore](http://magpi.cc/MagPiStore).

Alternatively, they will probably be making their way to Amazon soon too and, much like the *Official Projects Book*, will be available for Prime shipping.



**Above** The books are available from our store and we deliver to many countries

## FROM THE FORUM: KINDLING

The Raspberry Pi Forum is a hotbed of conversation and problem-solving for the community - join in via [raspberrypi.org/forums](http://raspberrypi.org/forums)

**I** have just bought a Kindle Paperwhite for times when I travel by coach. One of the things I would like to read on it is *The MagPi* magazine.

Just sending it as a PDF to the Kindle is not very satisfactory. Anybody worked out a good way of reformatting the magazine for the Kindle via something like Calibre or k2pdfopt?  
KeithSloan

We're not sure a version like that would work from the standard PDFs, as we use a lot of colour and images when creating the magazine. At the moment, we're not really in a position where we can create a version that would work better on Kindle, due to the amount of time needed to create the magazine in general. However, the magazine is Creative Commons BY-NC-SA licensed, so if someone wishes to take the PDF and create a more readable version for basic e-readers, they can certainly give it a go!

## WRITE TO US

Have you got something you'd like to say?

Get in touch via [magpi@raspberrypi.org](mailto:magpi@raspberrypi.org) or on The MagPi section of the forum at [raspberrypi.org/forums](http://raspberrypi.org/forums)

# TAKE US ANYWHERE



**SAVE 25%**  
with a Newsstand subscription  
(limited time offer)



**DO SCIENCE WITH THE SENSE HAT**  
WITH OUR NEW **ESSENTIALS E-BOOK**  
**ONLY £2.99 \$3.99**  
AVAILABLE ON THE MAGPI APP!



**FREE: DOWNLOAD ALL 30 ORIGINAL ISSUES**

# The MagPi Magazine

Available now for smartphones & tablets



*Subscribe from*  
**£2.29 or £26.99**  
rolling subscription      full year subscription

**Download it today - it's free!**

- Get all 30 legacy issues free
- Instant downloads every month
- Fast rendering performance
- Live links & interactivity



In association with:



# 3 Ucreate ASTRO PI KITS MUST BE WON!

## WHAT EXPERIMENTS WOULD YOU DO WITH A UCREATE ASTRO PI KIT?

Tell us by 25th April for your chance to win!

THE  
UCREATE  
ASTRO PI  
KIT  
COSTS  
£95.99  
AND  
INCLUDES:

- ▶ Raspberry Pi 2
- ▶ SenseHAT
- ▶ Official case
- ▶ SD card
- ▶ Power supply
- ▶ Keyboard & Mouse
- ▶ All required cables

### The UCreate AstroPi Kit

It contains everything you need to replicate ESA Astronaut Tim Peake's experiments in the ISS and devise your own.

[ucreatekit.co.uk/astropi](http://ucreatekit.co.uk/astropi)



Simply email [competition@raspberrypi.org](mailto:competition@raspberrypi.org) with a 100-word (max) overview of your idea.

Competition closes 25 April 2016. Prize is offered worldwide to participants aged 18 or over, except employees of the Raspberry Pi Foundation, the prize supplier, their families or friends. Winners will be notified by email after the draw date. By entering the competition, the winner consents to any publicity generated from the competition in print and online. Participants agree to receive occasional newsletters from The MagPi magazine (unless otherwise stated upon entry). We don't like spam. Participants' details will remain strictly confidential and won't be shared with third parties. Prizes are non-negotiable and no cash alternative will be offered.

## MATT RICHARDSON

Matt is Raspberry Pi's US-based product evangelist. Before that, he was co-author of *Getting Started with Raspberry Pi* and a contributing editor at *Make* magazine.



# A YEAR OF PI

On Raspberry Pi's birthday, **Matt Richardson** reflects on how much can happen in a year...

**A**t the front of a packed lecture hall at the University of Cambridge Computer Laboratory, Eben Upton welcomed everyone to Raspberry Pi's Big Birthday Bash. He made the observation that when you're working on Raspberry Pi so closely, it feels like things move slowly. But when you take a step back and look at the work done over the past year, it's quite incredible how much the world of Raspberry Pi has advanced and grown.

Since it was recently Raspberry Pi's birthday, it's a great time to take stock of things that have happened over the past year. Everything was off to a fast start with the new Raspberry Pi 2, the first Raspberry Pi with a quad-core processor. We then released the official enclosure into the wild and the long-awaited multi-touch display followed soon after. Just a few months ago, we made a huge splash with the \$5 Raspberry Pi Zero, the cheapest computer we've ever made, and attached it to the cover of issue 40 of *The MagPi*. On our birthday, Raspberry Pi 3 was released, adding the much-desired on-board wireless LAN and Bluetooth. Of course, we kept the price at \$35 for our newest top-of-the-line model.

But this year isn't just about new hardware – it's also new software, projects, programming, and people that have enhanced Raspberry Pi's community and ecosystem.

Software enhancements in the last year have included the upgrade of Raspbian to the Jessie version of Debian, the addition of a new GUI configuration tool, and many enhancements to the desktop experience. Eric Anholt has been making strong progress on the open-source GPU driver, which you can test-drive in the latest build of Raspbian.

In the last year, hardware hacking became more easily accessible within Python with the release GPIO

Zero and the implementation of sudo-less access to the GPIO pins. And thanks to the work of Gottfried Haider, an official build of the Java-based Processing language for graphical and creative coding was released for Raspberry Pi, and it supported the hardware capabilities of Raspberry Pi on day one.

## More than hardware

Raspberry Pi Foundation's outreach programmes had a very successful year as well. Two Raspberry Pis with Sense HATs were launched to the International Space Station. They were loaded up with applications designed and written by schoolchildren as part of our Astro Pi program, a partnership with the European Space Agency. Down here on Earth, we trained many teachers to become Raspberry Pi Certified Educators, including 40 in the first-ever Picademy held in the United States. And right now, nine young Raspberry Pi Creative Technologists are wrapping up their year-long exploration of the intersection of art and technology with an exhibition at Pi Towers at the end of April.

And best of all, our team is growing. We welcomed Philip Colligan as the Foundation's new CEO. Since he started, Philip has worked towards clarifying and communicating our charity's mission and goals. He also merged the Raspberry Pi Foundation with Code Club, welcoming a group of fantastic people who run a global network of volunteer-led after-school coding clubs for children aged 9 to 11.

In the world of Raspberry Pi, a lot happens in just one year. That's not to mention all the Raspberry Jams, projects, books, blogs, magazines, videos, and community growth we've seen. I wish I could go on, but I don't want to waste any more time reminiscing about the past when there's so much potential ahead of us. So here's to another big year of Raspberry Pi!



# FUZE

Teaching kids to code

"The FUZE is what  
the Raspberry Pi  
was designed for"



## The FUZE T2 Case Special Edition

-  Protect your Pi from physical & static damage
-  UK keyboard\* & 4 Extra USB ports
-  FUZE I/O Board with 40 way GPIO pass-through
-  Clearly labelled input output ports
-  2 Amp power supply and on/off switch!
-  Adds analogue ports, 4 in & 1 out
-  840 pin solderless breadboard (black)



Reviewed model FUZE T2-R

**Computer act!ve**

**BUY IT AWARD**

**PC PRO Recommended**

...makes the Pi more  
accessible than ever

**micro mart**

**EDITOR'S CHOICE**  
... it's certainly the **best**  
we've **ever** tested

# £99.99

FUZE T2-C-SE

\* USA & German keyboard layouts are also available. Prices include VAT but not shipping - see [fuze.co.uk](http://fuze.co.uk) for details

©2015 FUZE & the FUZE logo are trademarks of FUZE Technologies Ltd. Raspberry Pi and the Raspberry Logo are trademarks of the Raspberry Pi Foundation and are used with permission. All rights reserved.

**Compatible with  
Raspberry Pi V1 & V2**

**BONUS**  
Includes 8GB SD pre-  
configured with  
**FUZE BASIC**

FUZE Technology Ltd  
+44 (0) 1844 239 432 - [contact@fuze.co.uk](mailto:contact@fuze.co.uk)

Available from [www.fuze.co.uk](http://www.fuze.co.uk)

# CODE MUSIC

WITH SONIC PI  $\pi$

Get started today for  
just £2.99 / \$3.99

LIVE CODE & CREATE AMAZING SOUNDS

ON YOUR *Raspberry Pi*

*The*  
**MagPi**  
ESSENTIALS

From the makers of the  
official Raspberry Pi magazine



Available on the  
App Store



GET IT ON  
Google Play

Find it on  
*The*  
**MagPi**  
digital app

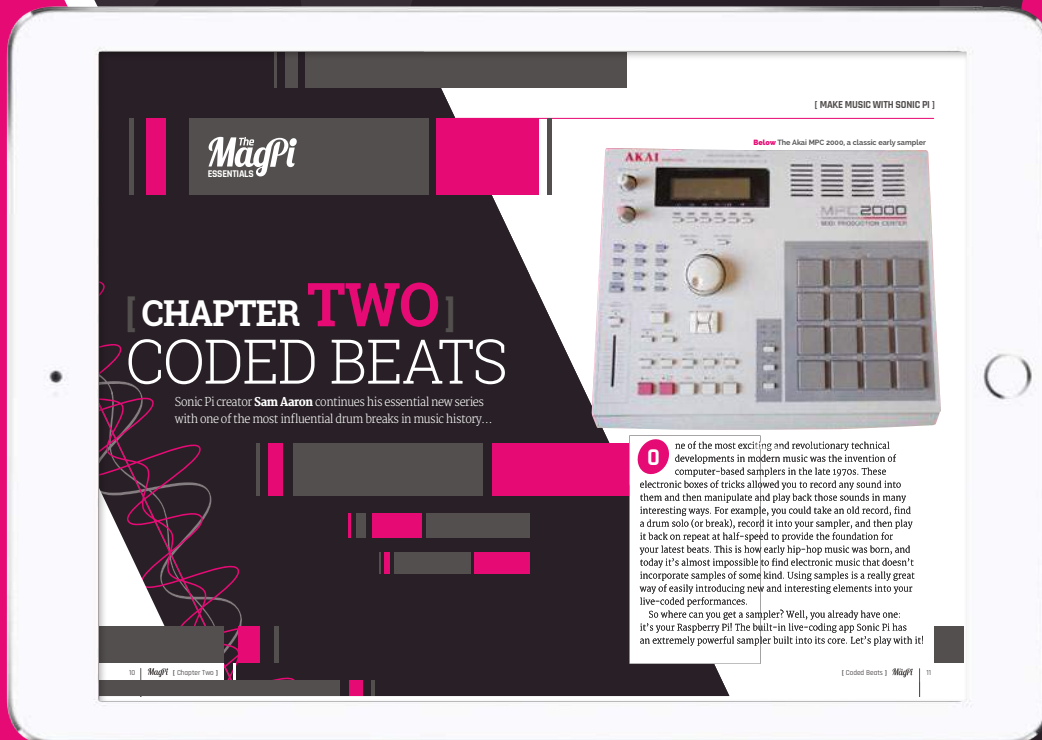

[magpi.cc/sonic-pi-book](http://magpi.cc/sonic-pi-book)



# Expand your Pi

Stackable expansion boards for the Raspberry Pi

## Serial Pi Plus

RS232 serial communication board. Control your Raspberry Pi over RS232 or connect to external serial accessories.

## Breakout Pi Plus

The Breakout Pi Plus is a useful and versatile prototyping expansion board for the Raspberry Pi

## ADC Differential Pi

8 channel 18 bit analogue to digital converter. I<sup>2</sup>C address selection allows you to add up to 32 analogue inputs to your Raspberry Pi.

## IO Pi Plus

32 digital 5V inputs or outputs. I<sup>2</sup>C address selection allows you to stack up to 4 IO Pi Plus boards on your Raspberry Pi giving you 128 digital inputs or outputs.

## RTC Pi Plus

Real-time clock with battery backup and 5V I<sup>2</sup>C level converter for adding external 5V I<sup>2</sup>C devices to your Raspberry Pi.

## 1 Wire Pi Plus

1-Wire<sup>®</sup> to I<sup>2</sup>C host interface with ESD protection diode and I<sup>2</sup>C address selection.

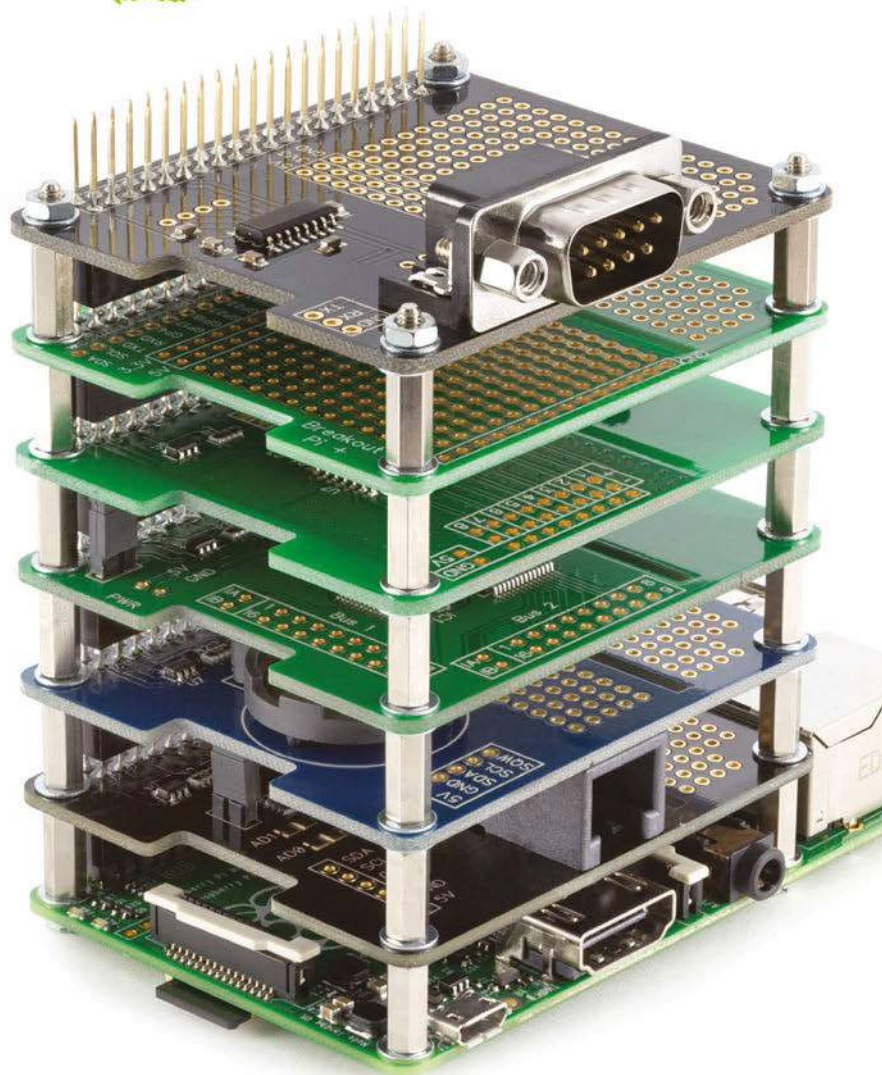

Now Available for the Pi Zero





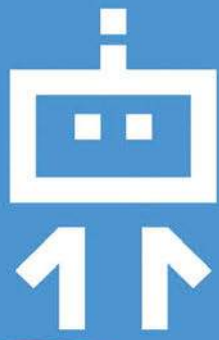

# DEXTER

INDUSTRIES

SAVE  
**15%**  
"MagPi15"  
discount code



## BrickPi

Build a LEGO robot with your Raspberry Pi!

## GoPiGo

Everything you need to build a Raspberry Pi robot!



## GrovePi

Connect hundreds of sensors to your Raspberry Pi!